

Zelio Logic

Smart Relay

User Manual

09/2017

EIO000002690.01

www.schneider-electric.com



RSPSupply - 1-888-532-2706 - <https://www.RSPSupply.com>
See the product details here

The information provided in this documentation contains general descriptions and/or technical characteristics of the performance of the products contained herein. This documentation is not intended as a substitute for and is not to be used for determining suitability or reliability of these products for specific user applications. It is the duty of any such user or integrator to perform the appropriate and complete risk analysis, evaluation and testing of the products with respect to the relevant specific application or use thereof. Neither Schneider Electric nor any of its affiliates or subsidiaries shall be responsible or liable for misuse of the information contained herein. If you have any suggestions for improvements or amendments or have found errors in this publication, please notify us.

You agree not to reproduce, other than for your own personal, noncommercial use, all or part of this document on any medium whatsoever without permission of Schneider Electric, given in writing. You also agree not to establish any hypertext links to this document or its content. Schneider Electric does not grant any right or license for the personal and noncommercial use of the document or its content, except for a non-exclusive license to consult it on an "as is" basis, at your own risk. All other rights are reserved.

All pertinent state, regional, and local safety regulations must be observed when installing and using this product. For reasons of safety and to help ensure compliance with documented system data, only the manufacturer should perform repairs to components.

When devices are used for applications with technical safety requirements, the relevant instructions must be followed.

Failure to use Schneider Electric software or approved software with our hardware products may result in injury, harm, or improper operating results.

Failure to observe this information can result in injury or equipment damage.

© 2017 Schneider Electric. All Rights Reserved.

Table of Contents



	Safety Information.	7
	About the Book.	11
Part I	Initial Power up and Discovering	19
Chapter 1	Initial Power up and Discovering	21
	Presentation of the Smart Relay Front Panel	22
	Characteristics and Connections.	24
	Control Keys on the Front Panel of the Smart Relay.	25
	Examples.	27
Part II	Functions Accessible from the Front Panel	33
Chapter 2	Overview of the Functions Accessible from the Front Panel.	35
	Functions Accessible from the Front Panel of the Smart Relay	35
Chapter 3	Input/Output Screen	37
	Inputs-Outputs Screen.	38
	TEXT and DISPLAY screen	40
Chapter 4	PROGRAMMING Menu	43
	Rules for Entering Ladder Diagrams	45
	Method for Entering a Contact or Coil	47
	Entering a Link.	50
	Entry of Function Block Parameters	52
	Deletion and Insertion of Diagram Lines	53
Chapter 5	PARAMETERS Menu	55
	PARAMETERS Menu	55
Chapter 6	MONITORING Menu	57
	MONITORING Menu	57
Chapter 7	RUN/STOP Menu	59
	RUN/STOP Menu	59
Chapter 8	CONFIGURATION Menu	61
	PASSWORD Menu	62
	FILTER Menu	65
	Zx KEYS Menu	66
	WATCHDOG CYCLE Menu	67
Chapter 9	CLEAR PROGRAM Menu	69
	CLEAR PROG Menu.	69

Chapter 10	TRANSFER Menu	71
	TRANSFER Menu	71
Chapter 11	VERSION Menu	75
	VERSION Menu	75
Chapter 12	LANGUAGE Menu	77
	LANGUAGE Menu	77
Chapter 13	DEFAULT Menu	79
	DEFAULT Menu	79
Chapter 14	CHANGE DATE/TIME Menu	83
	CHANGE DATE/TIME Menu	83
Chapter 15	CHANGE SUMMER/WINTER Menu	85
	CHANGE SUMMER/WINTER Menu	85
Part III	LD Language	87
Chapter 16	LD Language Elements	89
	Introduction	90
	Discrete Inputs	91
	Zx Keys	93
	Auxiliary Relays	95
	Discrete Outputs	98
	Timers	101
	Counters	110
	Fast Counter	116
	Counter Comparators	125
	Analog Comparators	127
	Clocks	132
	TEXT	135
	LCD Screen Backlighting	137
	Change to Summer / Winter Time	138
	Modbus Inputs/Outputs	140
	Message	141
Part IV	Creating and Debugging an Application	143
Chapter 17	Implementing an Application	145
	Presentation of Ladder Diagrams	146
	Using the Reverse Function	148
	Notation Used by the Smart Relay	150
	Application: Implementing a Two-way Switch	152

Chapter 18	Debugging an Application	159
	Introduction	160
	Run Mode Ladder Diagrams	162
	Run Mode Function Block Parameters	163
	Run Mode Menus	164
	Smart Relay Reaction to a Power Outage	165
Chapter 19	Transfer of Ladder Diagrams	167
	Transferring Ladder Diagrams	167
Chapter 20	Sample Application	169
	Specifications	170
	Specification Analysis	171
	Implementing the Solution	173
Part V	Diagnostics	177
Chapter 21	Diagnostics	179
	Smart Relay Messages	180
	Frequently Asked Questions	181
Appendices	183
Appendix A	Compatibility	185
	Zelio Soft 2 Software Version Versus Functions	186
	Compatibility between the memory cartridges and the version of the firmware on the smart relay	187
Index	189



Safety Information



Important Information

NOTICE

Read these instructions carefully, and look at the equipment to become familiar with the device before trying to install, operate, service, or maintain it. The following special messages may appear throughout this documentation or on the equipment to warn of potential hazards or to call attention to information that clarifies or simplifies a procedure.



The addition of this symbol to a “Danger” or “Warning” safety label indicates that an electrical hazard exists which will result in personal injury if the instructions are not followed.



This is the safety alert symbol. It is used to alert you to potential personal injury hazards. Obey all safety messages that follow this symbol to avoid possible injury or death.

DANGER

DANGER indicates a hazardous situation which, if not avoided, **will result in** death or serious injury.

WARNING

WARNING indicates a hazardous situation which, if not avoided, **could result in** death or serious injury.

CAUTION

CAUTION indicates a hazardous situation which, if not avoided, **could result in** minor or moderate injury.

NOTICE

NOTICE is used to address practices not related to physical injury.

PLEASE NOTE

Electrical equipment should be installed, operated, serviced, and maintained only by qualified personnel. No responsibility is assumed by Schneider Electric for any consequences arising out of the use of this material.

A qualified person is one who has skills and knowledge related to the construction and operation of electrical equipment and its installation, and has received safety training to recognize and avoid the hazards involved.

BEFORE YOU BEGIN

Do not use this product on machinery lacking effective point-of-operation guarding. Lack of effective point-of-operation guarding on a machine can result in serious injury to the operator of that machine.

⚠ WARNING
UNGUARDED EQUIPMENT
<ul style="list-style-type: none">• Do not use this software and related automation equipment on equipment which does not have point-of-operation protection.• Do not reach into machinery during operation.
Failure to follow these instructions can result in death, serious injury, or equipment damage.

This automation equipment and related software is used to control a variety of industrial processes. The type or model of automation equipment suitable for each application will vary depending on factors such as the control function required, degree of protection required, production methods, unusual conditions, government regulations, etc. In some applications, more than one processor may be required, as when backup redundancy is needed.

Only you, the user, machine builder or system integrator can be aware of all the conditions and factors present during setup, operation, and maintenance of the machine and, therefore, can determine the automation equipment and the related safeties and interlocks which can be properly used. When selecting automation and control equipment and related software for a particular application, you should refer to the applicable local and national standards and regulations. The National Safety Council's Accident Prevention Manual (nationally recognized in the United States of America) also provides much useful information.

In some applications, such as packaging machinery, additional operator protection such as point-of-operation guarding must be provided. This is necessary if the operator's hands and other parts of the body are free to enter the pinch points or other hazardous areas and serious injury can occur. Software products alone cannot protect an operator from injury. For this reason the software cannot be substituted for or take the place of point-of-operation protection.

Ensure that appropriate safeties and mechanical/electrical interlocks related to point-of-operation protection have been installed and are operational before placing the equipment into service. All interlocks and safeties related to point-of-operation protection must be coordinated with the related automation equipment and software programming.

NOTE: Coordination of safeties and mechanical/electrical interlocks for point-of-operation protection is outside the scope of the Function Block Library, System User Guide, or other implementation referenced in this documentation.

START-UP AND TEST

Before using electrical control and automation equipment for regular operation after installation, the system should be given a start-up test by qualified personnel to verify correct operation of the equipment. It is important that arrangements for such a check be made and that enough time is allowed to perform complete and satisfactory testing.

WARNING

EQUIPMENT OPERATION HAZARD

- Verify that all installation and set up procedures have been completed.
- Before operational tests are performed, remove all blocks or other temporary holding means used for shipment from all component devices.
- Remove tools, meters, and debris from equipment.

Failure to follow these instructions can result in death, serious injury, or equipment damage.

Follow all start-up tests recommended in the equipment documentation. Store all equipment documentation for future references.

Software testing must be done in both simulated and real environments.

Verify that the completed system is free from all short circuits and temporary grounds that are not installed according to local regulations (according to the National Electrical Code in the U.S.A, for instance). If high-potential voltage testing is necessary, follow recommendations in equipment documentation to prevent accidental equipment damage.

Before energizing equipment:

- Remove tools, meters, and debris from equipment.
- Close the equipment enclosure door.
- Remove all temporary grounds from incoming power lines.
- Perform all start-up tests recommended by the manufacturer.

OPERATION AND ADJUSTMENTS

The following precautions are from the NEMA Standards Publication ICS 7.1-1995 (English version prevails):

- Regardless of the care exercised in the design and manufacture of equipment or in the selection and ratings of components, there are hazards that can be encountered if such equipment is improperly operated.
- It is sometimes possible to misadjust the equipment and thus produce unsatisfactory or unsafe operation. Always use the manufacturer's instructions as a guide for functional adjustments. Personnel who have access to these adjustments should be familiar with the equipment manufacturer's instructions and the machinery used with the electrical equipment.
- Only those operational adjustments actually required by the operator should be accessible to the operator. Access to other controls should be restricted to prevent unauthorized changes in operating characteristics.

About the Book



At a Glance

Document Scope

This manual describes the use of functions accessible from the front panel of the smart relay.

This document is divided into 5 parts and addresses the following topics:

- Part I: Powering up and Discovering the Smart Relay
 - General presentation of the smart relay
- Part II: Functions Accessible from the Front Panel
 - Description of the interface and the menus of the smart relay
- Part III: LD Language
 - Description of automation functions available for programming in LADDER
- Part IV: Creating, Debugging and Saving an Application
 - Example of programming
 - Presentation of tools for debugging and saving an application
- Part V: Diagnostics
 - Help for finding solutions to detected errors

Validity Note

This document has been updated for the release of Zelio Soft 2 V5.1.

The technical characteristics of the devices described in this document also appear online. To access this information online:

Step	Action
1	Go to the Schneider Electric home page www.schneider-electric.com .
2	In the Search box type the reference of a product or the name of a product range. <ul style="list-style-type: none">● Do not include blank spaces in the reference or product range.● To get information on grouping similar modules, use asterisks (*).
3	If you entered a reference, go to the Product Datasheets search results and click on the reference that interests you. If you entered the name of a product range, go to the Product Ranges search results and click on the product range that interests you.
4	If more than one reference appears in the Products search results, click on the reference that interests you.

Step	Action
5	Depending on the size of your screen, you may need to scroll down to see the data sheet.
6	To save or print a data sheet as a .pdf file, click Download XXX product datasheet .

The characteristics that are presented in this manual should be the same as those characteristics that appear online. In line with our policy of constant improvement, we may revise content over time to improve clarity and accuracy. If you see a difference between the manual and online information, use the online information as your reference.

For product compliance and environmental information (RoHS, REACH, PEP, EOLI, etc.), go to www.schneider-electric.com/green-premium.

Product Related Information

DANGER

HAZARD OF ELECTRIC SHOCK, EXPLOSION OR ARC FLASH

- Disconnect all power from all equipment including connected devices prior to removing any covers or doors, or installing or removing any accessories, hardware, cables, or wires except under the specific conditions specified in the appropriate hardware guide for this equipment.
- Always use a properly rated voltage sensing device to confirm the power is off where and when indicated.
- Replace and secure all covers, accessories, hardware, cables, and wires and confirm that a proper ground connection exists before applying power to the unit.
- Use only the specified voltage when operating this equipment and any associated products.

Failure to follow these instructions will result in death or serious injury.

DANGER

POTENTIAL FOR EXPLOSION

- Only use this equipment in non-hazardous locations, or in locations that comply with Class I, Division 2, Groups A, B, C and D.
- Do not substitute components which would impair compliance to Class I, Division 2.
- Do not connect or disconnect equipment unless power has been removed or the location is known to be non-hazardous.
- Do not use the USB port(s) unless the location is known to be non-hazardous.

Failure to follow these instructions will result in death or serious injury.

WARNING

LOSS OF CONTROL

- The designer of any control scheme must consider the potential failure modes of control paths and, for certain critical control functions, provide a means to achieve a safe state during and after a path failure. Examples of critical control functions are emergency stop and overtravel stop, power outage and restart.
- Separate or redundant control paths must be provided for critical control functions.
- System control paths may include communication links. Consideration must be given to the implications of unanticipated transmission delays or failures of the link.
- Observe all accident prevention regulations and local safety guidelines.¹
- Each implementation of this equipment must be individually and thoroughly tested for proper operation before being placed into service.

Failure to follow these instructions can result in death, serious injury, or equipment damage.

¹ For additional information, refer to NEMA ICS 1.1 (latest edition), "Safety Guidelines for the Application, Installation, and Maintenance of Solid State Control" and to NEMA ICS 7.1 (latest edition), "Safety Standards for Construction and Guide for Selection, Installation and Operation of Adjustable-Speed Drive Systems" or their equivalent governing your particular location.

WARNING

UNINTENDED EQUIPMENT OPERATION

- Only use software approved by Schneider Electric for use with this equipment.
- Update your application program every time you change the physical hardware configuration.

Failure to follow these instructions can result in death, serious injury, or equipment damage.

- Verify the operating conditions, as described in the Product Datasheet for your particular reference(s).
- Install the smart relay only in environments described in the Product Datasheet. Do not use the smart relay in environments subject to excessive temperatures, elevated relative humidity, condensation, corrosive gases, or excessive shocks.
- The smart relay should be used in "Pollution level 2" environments. This level defines the effect of pollution on the insulation.
Definition of level 2 Pollution: Only non-conductive pollution arises, except for occasional temporary conductivity caused by condensation. Do not use smart relays in environments lower than those specified in IEC Standard 60664-1.

-
- Fluctuations or variations in the power supply voltage should not exceed the tolerance thresholds stated in the technical characteristics in the Product Datasheet for your particular reference(s).

NOTE: You can find the Product Datasheet online at www.schneider-electric.com. If you are unsure of the technical characteristics, contact Schneider Electric.

- Verify that there is adequate short circuit protection.
- Take any steps necessary to prevent involuntary activation of the smart relay.
- Automation and control devices must be installed in areas where they are protected against any risk of involuntary activation.

This product contains a battery.

DANGER

EXPLOSION, FIRE, OR CHEMICAL BURNS

- Do not attempt to disassemble the smart relay, replace or recharge the battery, heat above 100°C (212°F), or incinerate.
- Properly dispose of the smart relay.

Failure to follow these instructions will result in death or serious injury.

WARNING

UNINTENDED EQUIPMENT OPERATION

- Use appropriate safety interlocks where personnel and/or equipment hazards exist.
- Install and operate this equipment in an enclosure appropriately rated for its intended environment and secured by a keyed or tooled locking mechanism.
- Use the sensor and actuator power supplies only for supplying power to the sensors or actuators connected to the module.
- Power line and output circuits must be wired and fused in compliance with local and national regulatory requirements for the rated current and voltage of the particular equipment.
- Do not use this equipment in safety-critical machine functions unless the equipment is otherwise designated as functional safety equipment and conforming to applicable regulations and standards.
- Do not disassemble, repair, or modify this equipment.
- Do not connect any wiring to unused connections, or to connections designated as No Connection (N.C.).

Failure to follow these instructions can result in death, serious injury, or equipment damage.

Special case arises out of the use of the SR2COM01 modem communication extension. Sending commands may lead to modification of the status of smart relay outputs or accidental enabling of controlled equipment.

It is important to:

- Know how the commands will affect the process or the controlled equipment,
- Take any preventive measures necessary to help ensure safety when making modifications.

Care must be taken and provisions made for use of the modem functionality as a remote control device to avoid inadvertent consequences of commanded machine operation, smart relay state changes, or alteration of data memory or machine operating parameters.

WARNING

UNINTENDED EQUIPMENT OPERATION

- Ensure that there is a local, competent, and qualified observer present when operating from a remote location.
- Configure and install a means of local control over the starting or stopping of the smart relay such that it can be maintained regardless of the remote commands sent to the smart relay.

Failure to follow these instructions can result in death, serious injury, or equipment damage.

Related Documents

Document title	Reference
Zelio Logic Programming Guide	EIO0000002612 (ENG) EIO0000002613 (FRE) EIO0000002614 (GER) EIO0000002615 (SPA) EIO0000002616 (ITA) EIO0000002617 (POR)
Zelio Soft 2 Applications Example Guide	EIO0000002600 (ENG) EIO0000002602 (GER) EIO0000002601 (FRE) EIO0000002603 (SPA) EIO0000002604 (ITA) EIO0000002605 (POR)
SR2A..... / SR2B..... Instruction Sheet	1724026_01A55
SR2D..... / SR2E..... Instruction Sheet	1724028_01A55
SR3B..... Instruction Sheet	1724027_01A55

You can download these technical publications and other technical information from our website at <http://www.schneider-electric.com/en/download>.

Terminology Derived from Standards

The technical terms, terminology, symbols and the corresponding descriptions in this manual, or that appear in or on the products themselves, are generally derived from the terms or definitions of international standards.

In the area of functional safety systems, drives and general automation, this may include, but is not limited to, terms such as *safety, safety function, safe state, fault, fault reset, malfunction, failure, error, error message, dangerous, etc.*

Among others, these standards include:

Standard	Description
EN 61131-2:2007	Programmable controllers, part 2: Equipment requirements and tests.
ISO 13849-1:2008	Safety of machinery: Safety related parts of control systems. General principles for design.
EN 61496-1:2013	Safety of machinery: Electro-sensitive protective equipment. Part 1: General requirements and tests.
ISO 12100:2010	Safety of machinery - General principles for design - Risk assessment and risk reduction
EN 60204-1:2006	Safety of machinery - Electrical equipment of machines - Part 1: General requirements
EN 1088:2008 ISO 14119:2013	Safety of machinery - Interlocking devices associated with guards - Principles for design and selection
ISO 13850:2006	Safety of machinery - Emergency stop - Principles for design
EN/IEC 62061:2005	Safety of machinery - Functional safety of safety-related electrical, electronic, and electronic programmable control systems
IEC 61508-1:2010	Functional safety of electrical/electronic/programmable electronic safety-related systems: General requirements.
IEC 61508-2:2010	Functional safety of electrical/electronic/programmable electronic safety-related systems: Requirements for electrical/electronic/programmable electronic safety-related systems.
IEC 61508-3:2010	Functional safety of electrical/electronic/programmable electronic safety-related systems: Software requirements.
IEC 61784-3:2008	Digital data communication for measurement and control: Functional safety field buses.
2006/42/EC	Machinery Directive
2014/30/EU	Electromagnetic Compatibility Directive
2014/35/EU	Low Voltage Directive

In addition, terms used in the present document may tangentially be used as they are derived from other standards such as:

Standard	Description
IEC 60034 series	Rotating electrical machines
IEC 61800 series	Adjustable speed electrical power drive systems
IEC 61158 series	Digital data communications for measurement and control – Fieldbus for use in industrial control systems

Finally, the term *zone of operation* may be used in conjunction with the description of specific hazards, and is defined as it is for a *hazard zone* or *danger zone* in the *Machinery Directive (2006/42/EC)* and *ISO 12100:2010*.

NOTE: The aforementioned standards may or may not apply to the specific products cited in the present documentation. For more information concerning the individual standards applicable to the products described herein, see the characteristics tables for those product references.

Part I

Initial Power up and Discovering

Initial Power up and Discovering.

Chapter 1

Initial Power up and Discovering

Subject of this Chapter

This chapter presents the operation and main characteristics of the smart relay.

What Is in This Chapter?

This chapter contains the following topics:

Topic	Page
Presentation of the Smart Relay Front Panel	22
Characteristics and Connections	24
Control Keys on the Front Panel of the Smart Relay	25
Examples	27

Presentation of the Smart Relay Front Panel

Introduction

Smart relays are designed to simplify the electrical wiring of intelligent solutions. A smart relay is simple to implement. Its flexibility and its high performance allow users to save time and money.

Description of the Smart Relay Front Panel

The illustration below presents the elements of the front panel of the smart relay:

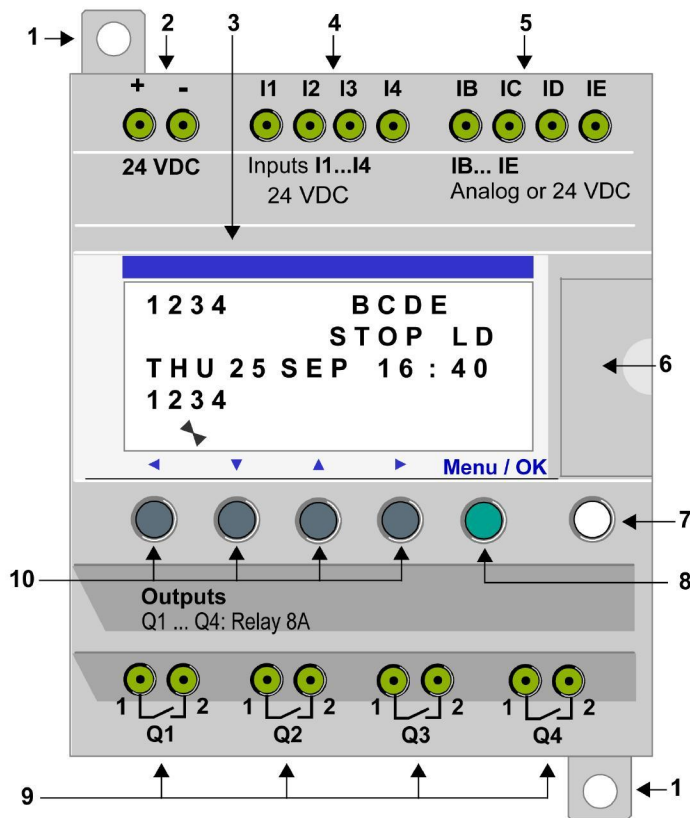

Prompt	Element
1	Retractable mounting feet.
2	Screw terminal block for the power supply.
3	LCD display, 4 lines, 18 characters.

Prompt	Element
4	Screw terminal block for discrete inputs.
5	Screw terminal block for analog inputs. 0-10 Volts, usable as discrete inputs depending on the reference.
6	Slot for backup memory or PC connection cable.
7	Shift key (white).
8	Menu/OK key (green) for selection and confirmation.
9	Relay output screw terminal block.
10	Navigation keys (gray) or, alternatively, can be configured as Z keys.

Description of the LCD

The illustration below presents an example of LCD display elements when displaying the INPUT-OUTPUT screen:

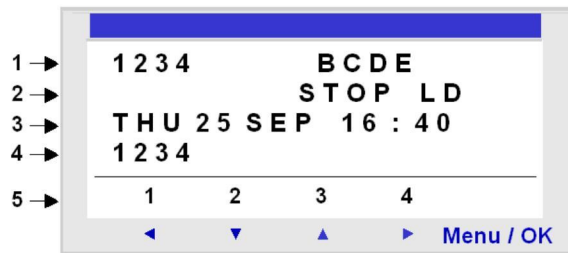

Prompt	Element
1	Input status display (B...E represent the analog inputs). NOTE: An ACTIVE input or output is displayed in reverse video.
2	Display of the operating mode (RUN/STOP) and programming type (LD/FBD).
3	Display of the date (day and time for products with clock).
4	Output status display.
5	Contextual menus / pushbuttons / icons indicating the operating modes.

Characteristics and Connections

Introduction

Here is detailed information on the characteristics of DC smart relay connections.

Connection to a Regulated DC Power Supply

Connect the smart relay to a regulated DC power supply:



Connection to a Rectified Filtered Regulated Power Supply

It is also possible to connect the smart relay to a rectified filtered regulated power supply:



Comply with the following characteristics, according to the type of smart relay:

SR2 ... BD	SR2 ... JD
U max < 30 V U min > 19.2 V	U max < 14,4 V U min > 10.4 V

Prohibited Connection

It is prohibited to connect the smart relay to a rectified non-filtered power supply:



Control Keys on the Front Panel of the Smart Relay

Description

The keys located on the front panel of the smart relay are used to configure, program and control the application and monitor the application's progress.

Illustration:

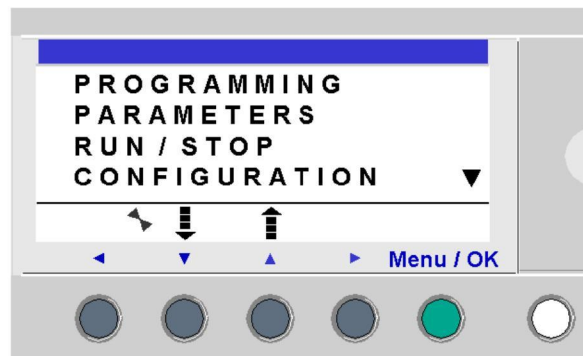

NOTE: The LCD screen is illuminated for 30 seconds when a key is pressed on the front panel.

Shift Key

The **Shift** key is the white key located on the right side of the LCD screen.

When the **Shift** key is pressed, a contextual menu is displayed above the Z keys.

Menu/OK Key

The **Menu/OK** key is the green key located below the LCD screen on the right side.

This key is used for confirmation of a menu, sub-menu, program, parameter, etc.

Zx Keys

The Zx keys are the gray keys aligned from left (Z1) to right (Z4) and located under the LCD. The arrows indicating the movement direction associated with navigation are marked above the keys.

The navigation keys are used to move left or right, down or up.

The position on the screen appears as a flashing zone:

- Square for a position that corresponds to a contact (only in programming menu),
- Round for a link (only in programming menu).

NOTE: When the keys may be used for other actions apart from navigation, a contextual menu bar is displayed (e.g.: 1, 2, 3 and 4 as Zx-type keys).

Contextual Menus

When the cursor is placed on a modifiable parameter, if the **Shift** key is pressed, a contextual menu appears.

Illustration:



Using the contextual menu functions:

- **+ / -:** Used to scroll through the various possible values of the selected field (types of inputs, outputs, automation functions, numbers, numerical values, etc),
- **Ins.:** Inserts a line,
- **Del.:** Deletes the selected element, or the entire line if it is empty,
- **Param.:** Displays the specific parameter screen for the automation function (visible only if the automation function contains a parameter),
- **← ↑ ↓ →:** Direction of the connection (available only if the cursor is placed over a link box),
- **1 2 3 4:** This line appears when the keys are used as Zx key-type inputs in a program.

Password Protection Illustration:



The key indicates that the program is password-protected.

Other Condition Illustration:

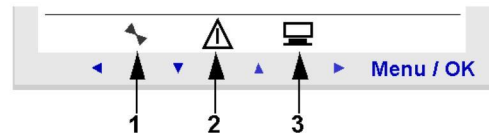

- 1: Indicates the state of the smart relay. In RUN it is in motion, in STOP it is immobile.
- 2: Indicates that errors have been detected.
- 3: The smart relay is physically connected to the programming software.





Examples







Introduction



We will now see two examples of how to use the smart relay keys.

Language Selection

Example 1: Here are details on how to select the language of the smart relay:



Step	Action
1	<p>Apply power On initial powering-up, the INPUT-OUTPUT screen is displayed (See: <i>Inputs-Outputs Screen, page 38</i>). By default, the selected language is English. Illustration:</p> 
2	<p>From the INPUT-OUTPUT screen, enter the MAIN menu , then go to the CONFIGURATION menu LANGUAGE, by pressing 7 times on the down navigation key .</p> <p>Illustration:</p>  <p>Note: the selected command flashes.</p>

Step	Action
3	<p>Enter in the language selection menu.</p> <p style="text-align: center;">Menu / OK</p>  <p>Illustration:</p>  <p>Note: The activated option flashes and it is also indicated by a black diamond.</p>
4	<p>Select and confirm the language (the selection is shown in flashing text).</p> <p style="text-align: center;">  or  then  </p> <p>The Menu/OK key is used to confirm the selection of the new language. The display returns to the MAIN menu when the smart relay is in STOP mode.</p> <p>Illustration:</p> 



Step	Action
5	<p>Return to the INPUT-OUTPUT screen using the left navigation key.</p>  <p>Illustration:</p> 

Modification of Date and Hour

Example 2: Here are details on procedure to follow to modify the date and time.

Step	Action
1	<p>From the INPUT-OUTPUT screen, enter the MAIN menu, then go to the CHANGE D/H menu:</p>  then  9 times in LD mode 7 times in FBD mode
	<p>Illustration:</p> 

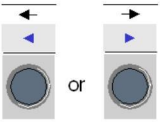
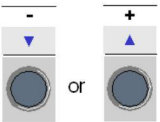
Step	Action
2	<p data-bbox="435 508 855 536">Enter the date and hour configuration menu:</p> <div data-bbox="619 553 730 646" style="text-align: center;"><p data-bbox="619 553 730 581">Menu / OK</p></div> <p data-bbox="435 699 539 727">Illustration:</p> <div data-bbox="443 746 818 924" style="border: 1px solid black; padding: 5px; text-align: center;"><p data-bbox="480 776 663 804">CHANGE D/H</p><p data-bbox="480 804 756 831">THU 07 JUL 2003</p><p data-bbox="555 831 715 859">16 : 27 30 s</p><hr data-bbox="459 859 802 864"/><p data-bbox="480 859 735 887">CAL ± 02 secs /WK</p></div>

Step	Action
3	<p>Select the parameter to modify using the arrows (the selection is highlighted by the flashing of the parameter):</p>  <p>Modify the parameter using the navigation keys:</p>  <p>Then confirm with the Menu/OK key:</p>  <p>The Menu/OK key is used to confirm the modifications. The display returns to the MAIN menu when the smart relay is in STOP mode). Illustration:</p> 

Step	Action
4	<p data-bbox="435 508 794 536">Return to the INPUT-OUTPUT screen</p> <div data-bbox="646 553 699 646" style="text-align: center;"></div> <p data-bbox="435 699 539 727">Illustration:</p> <div data-bbox="440 741 817 920" style="border: 1px solid gray; padding: 5px; text-align: center;"><p data-bbox="469 769 738 820">1 2 3 4 B C D E S T O P L D</p><p data-bbox="469 822 719 845">F R I 2 5 N O V 1 6 : 4 0</p><p data-bbox="469 848 533 871">1 2 3 4</p><hr data-bbox="469 878 794 883"/><p data-bbox="512 878 533 901">⚡</p></div>

Part II

Functions Accessible from the Front Panel

Subject of this Section

This section describes the functions that can be accessed from the front panel of the smart relay.

What Is in This Part?

This part contains the following chapters:

Chapter	Chapter Name	Page
2	Overview of the Functions Accessible from the Front Panel	35
3	Input/Output Screen	37
4	PROGRAMMING Menu	43
5	PARAMETERS Menu	55
6	MONITORING Menu	57
7	RUN/STOP Menu	59
8	CONFIGURATION Menu	61
9	CLEAR PROGRAM Menu	69
10	TRANSFER Menu	71
11	VERSION Menu	75
12	LANGUAGE Menu	77
13	DEFAULT Menu	79
14	CHANGE DATE/TIME Menu	83
15	CHANGE SUMMER/WINTER Menu	85

Chapter 2

Overview of the Functions Accessible from the Front Panel

Functions Accessible from the Front Panel of the Smart Relay

Description

From the front panel of the smart relay, you may:

- Program (in LD mode),
- Configure,
- Control the application,
- Monitor the performance of the application.

Illustration:

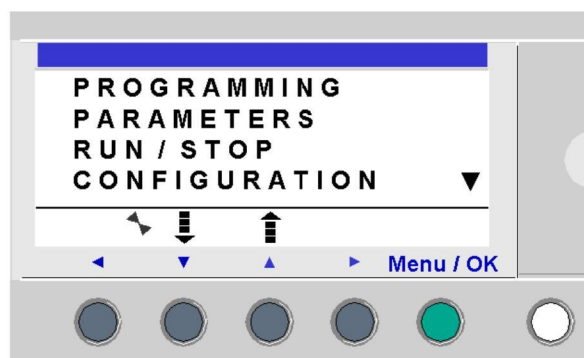

The line flashes to indicate where you are positioned.

The up triangle ▲ on the right side of the LCD screen indicates that possible up options exist. The down triangle ▼ indicates that possible down options exist.



To return to the previous menu, press left navigation key.

NOTE: The LCD screen is illuminated for 30 seconds when a key is pressed on the front panel.

Managing Menus

The inputs-outputs screen is displayed by default whether the mode be LD or FBD.

Pressing the **Menu/OK** key switches the display from the inputs-outputs screen to the main menu.

The menu on the first row which is selected by default (flashing). The  and  navigation keys can be used to place the cursor over the other menus.

Press the green **Menu/OK** key to display the screen corresponding to the selected menu or to move onto the first sub-menu.

Differences Between LD and FBD Modes

Certain menus are specific to either LD or FBD mode.

Menu	LD	FBD
PROGRAMMING	✓	
MONITORING	✓	
PARAMETERS	✓	✓
RUN / STOP	✓	✓
CONFIGURATION		
PASSWORD	✓	✓
FILTER	✓	✓
Zx KEYS	✓	
WATCHDOG CYCLE	✓	✓
CLEAR PROG.	✓	
TRANSFER	✓	✓
VERSION	✓	✓
LANGUAGE	✓	✓
DEFAULT	✓	✓
CHANGE D/T	✓	✓
CHANGE SUMM/WINT	✓	✓

Configuring Extensions

Extensions added to the smart relay may only be configured from the programming software. See on-line help of the programming software for more information.

Chapter 3

Input/Output Screen

Subject of this Chapter

This chapter describes the characteristics of the input-output screen.

What Is in This Chapter?

This chapter contains the following topics:

Topic	Page
Inputs-Outputs Screen	38
TEXT and DISPLAY screen	40

Inputs-Outputs Screen

Description

The inputs-outputs screen is the highest-level interface. It is displayed by default, when no (TEXT or DISPLAY) display function is active and regardless of:

- the programming type: LD or FBD,
- the operating mode: STOP or RUN.

Illustration:

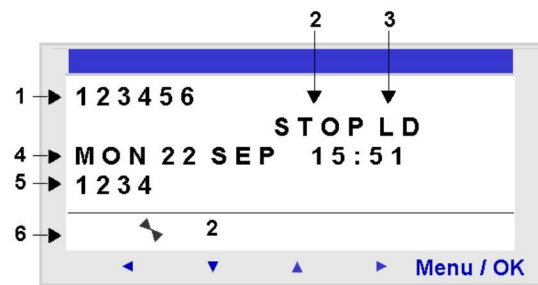

The inputs-outputs screen can be used to view:

1. The state of the inputs: 1 to 9, A to P,
2. The operating mode: RUN / STOP,
3. The programming type used: LD/FBD,
4. The date and time for products with a clock,
5. The state of outputs: 1 to 9, A to G,
6. Z keys: 1 to 4.

In Simulation mode or Monitoring mode when the program is in RUN, the active states of the inputs and outputs are indicated in reverse video.

Access to the Main Menu

Pressing the **Menu/OK** key switches the display from the inputs-outputs screen to the main menu:

- PROGRAMMING (LD STOP mode),
- MONITORING (LD RUN mode),
- PARAMETERS,
- RUN / STOP,
- CONFIGURATION (STOP mode),
- CLEAR PROG. (LD STOP mode),
- TRANSFER (STOP mode),
- VERSION,
- LANGUAGE,
- DEFAULT,

- CHANGE D/T,
- CHANGE SUMM/WINT.

The display automatically returns to the inputs-outputs menu on exiting other menus and sub-menus.

TEXT and DISPLAY screen

Description

The display functions are used to display text or numerical values (current value, preset value, etc.) on the LCD display instead of the INPUTS-OUTPUTS states.

Illustration:

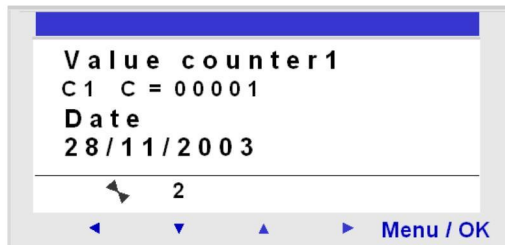

NOTE: The display functions are programmable only from the programming software (see the on-line help for the programming software for more information) in LD mode for the TEXT function, in LD mode or FBD mode for the DISPLAY function.

Switching Between the Screens

It is possible to go from the TEXT or DISPLAY screen to the INPUTS-OUTPUTS screen and vice-versa. Proceed as follows:

Step	Action
1	Press and hold down the Shift key and press the Menu/OK key.

Modify Displayed Values

In RUN mode, when the TEXT / DISPLAY screen is displayed, it is possible to modify, from the front panel, the displayed values whose modification was authorized in the block function parameters window.

To do this, proceed as follows:

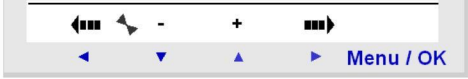
Step	Action
1	Press the Shift key (white key). Result: Param is displayed at the bottom of the screen.
2	Press the ▶ key (without releasing the Shift key) to display the contextual menu. Result: The parameter which can be modified flashes and the following contextual menu is displayed: 
3	Select the parameter to be modified using the navigation keys ◀ and ▶ (the value which is available for modification flashes).
4	Modify the parameter value with the + (▲) and - (▼) keys.
5	Confirm the changes by pressing the Menu/OK key. Result: The display returns to the INPUTS-OUTPUTS screen or the TEXT / DISPLAY screen.

Chapter 4

PROGRAMMING Menu

Subject of this Chapter

This chapter describes the characteristics of the **PROGRAMMING** menu specific to LD mode / smart relay in **STOP** mode.

This function lets you enter the ladder diagrams that will work on the smart relay.

This program is written only using a ladder diagram LD.

Illustration:

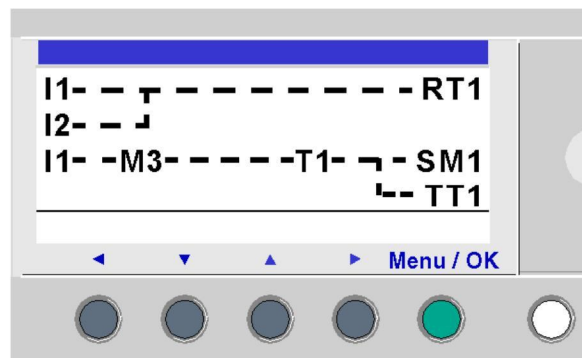

NOTE: The smart relays to which have been added an Input/Output extension are programmable only in **FBD** mode from the programming software. See on-line help of the programming software for more information.

NOTE: In front panel programming with 240 lines, program memory is stored in two banks. One bank contains lines 1 to 120, and the other bank contains lines 121 to 240. You must do the program modifications in the first part (line 1 to 120) or in the last part (line 121 to 240) and save them before being able to modify the other part.

When the cursor moves from line 120 to 121, the front panel notifies you to save the modification (see picture below) and display the line 121. Then modification could be done on last part of the ladder.

When the cursor moves from line 121 to 120, the front panel notifies you to save the modification (see picture below) and display the line 120. Then modification could be done on first part of the ladder.



NOTE:

No link between the upper part (line 1 to 120) and the lower part (line 121 to 240) could be made in Ladder front panel programming:

- On line 120, it is not possible to insert a descending link (the descending link is displayed in the contextual menu but is ineffective).
- On line 121, it is not possible to insert an ascending link (the ascending link is displayed in the contextual menu but is ineffective).
- Insert a line in the upper part is possible only if line 120 is empty. If a line is inserted in upper part, the lower part is not modified.
- Delete a line in the upper part does not modify the lower part (line 121 does not move to line 120).

What Is in This Chapter?

This chapter contains the following topics:

Topic	Page
Rules for Entering Ladder Diagrams	45
Method for Entering a Contact or Coil	47
Entering a Link	50
Entry of Function Block Parameters	52
Deletion and Insertion of Diagram Lines	53

Rules for Entering Ladder Diagrams

Description

The maximum number of lines in Ladder language that a smart relay allows you to enter is either:

- 120 lines, if an SR2COM01 communication interface has been selected in the configuration,
- 240 lines, without an SR2COM01 communication interface.

NOTE: The maximum number of program lines also depends on the firmware version (*see page 186*).

The smart relay's display screen is used to display these lines, 4 at a time, in the following manner:

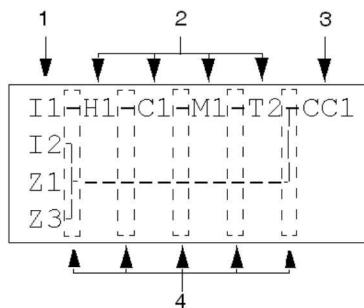

Prompt	Element
1	Column reserved for contacts (conditions).
2	Column reserved for contacts (conditions) and for links.
3	Column reserved for coils (actions).
4	Column reserved for links.

Each line comprises 5 fields each with 2 characters reserved for contacts (conditions). The 4 central columns can also accept links. The last three-character column is reserved for coils (actions).

Links must be entered between the contact and coil columns.

A ladder diagram is entered into the smart relay using the front panel keys (see *Control Keys on the Front Panel of the Smart Relay, page 25*).

Data Entry Rules

Make sure you respect the following rules when you enter a ladder diagram:

Rules	Incorrect	Correct
Each coil must only be entered once in the right hand column	<pre> I1-----[Q1 I2-I3-----TT1 T1-----[Q1 Z1 • </pre>	<pre> I1-----[Q1 T1] I2-I3-----TT1 Z1 • </pre>
Elements used as contacts may be entered as many times as necessary in the 5 left hand columns.		<pre> I1-----TT1 T1-----[Q1 I3-T1-----[M2 I1-M2-----[Q2 </pre>
Links must always run from left to right.	<pre> I1-I2-I3]] I4-I5-I6-[Q1 </pre>	<pre> I1-I2-I3-----[M1 M1----I4-I5-I6-[Q1 </pre>
If S coils (SET) are used in a diagram, also use an R (Reset) coil.	If no R (Reset) coils are used, the corresponding coil will always be set to 1.	An R (Reset) coil must be used for reset purposes.

NOTE: Smart relays run programs from top to bottom and from left to right.

Method for Entering a Contact or Coil

Description

NOTE: Accessible only in **LD mode** / smart relay in **STOP** mode.

This section describes the procedures for performing the following operations:

- Entering an element,
- Modifying an element,
- Deleting an element.

This is valid for: contact or coil elements, whether the parameters can be set or not.



Entering an Element

When entering an element, the following rules must be observed:

- **Contact:** In any column except the last,
- **Coil:** Only in the last column.

The presence of a square, flashing cursor means an element can be inserted.

Entry procedure:

Step	Action
1	<p>Place the flashing cursor at the required location. The navigation keys can be used move the cursor in the direction of the arrows on the navigation keys ◀ ▼ ▲ ▶.</p> <p>Illustration:</p> 
2	<p>Press the Shift key to display the contextual menu.</p> <p>Illustration:</p>  <p>By simultaneously pressing Shift and one of the ▼ ▲ (- and +) keys, the first letter of the element is inserted: I for a contact and Q for a coil, followed by the number 1.</p>

Step	Action
3	<p>Choose the type of element desired by pressing simultaneously on Shift and + or -. This makes the different types of elements scroll down cyclically, in the following order:</p> <ul style="list-style-type: none"> • For the contacts: I, i, Z, z, N, n, M, m, Q, q, T, t, C, c, K, k, V, v, A, a, H, h, W, w, S, s. • For the coils: M, N, Q, T, C, K, X, L, S. <p>See the chapter <i>LD Language Elements</i>, page 89.</p>
4	<p>Release the Shift key to have access to the navigation keys: ◀ ▼ ▲ ▶. Pressing the ▶ key places the cursor over the corresponding number 1.</p>
5	<p>Simultaneously hold down the Shift and + keys to increment the number of the element (2, 3, 4, ..., 9, A, etc.).</p> <p>NOTE: The numbers for functional blocks are limited to the number of blocks of the type available in the smart relay. In the case of extensible smart relays, the inputs and outputs numbers are used to program the extension to maximum size.</p> <p>In entering a contact, once this step is completed, the entry is terminated. In entering a coil, you must additionally select the function of the coil.</p>
6	<p>Release the Shift key to have access to the navigation keys: ◀ ▼ ▲ ▶.</p>
7	<p>Steps 7 to 9 are only necessary when entering a coil. Position the cursor on the function of the coil by pressing twice on the ◀ key.</p>
8	<p>Select the desired function by pressing simultaneously on the Shift key and the + or - key. This will scroll through the different coil functions available.</p>
9	<p>Release the Shift key to have access to the navigation keys: ◀ ▼ ▲ ▶.</p>

NOTE: Confirming some function block coils will bring-up a function block parameter setting screen.

Modifying an element

To modify an existing control diagram element:

- Position the pointer over the element to modify: Step 1 in the previous table,
- Select the desired new element: Steps 3 to 6.

Initialization

Status of contacts on program initialization:

- A normally open contact (direct state) is inactive,
- A normally closed contact (reverse state) is active,

Deleting an Element

To delete an element:

- Place the cursor over the element to delete
- Simultaneously press the **Shift** and **Del (Menu/OK)** keys.

Two scenarios are possible, depending on the position of the cursor at the time of the deletion:

- Cursor over an element: the element is deleted,
- Cursor over an empty position of the line: the line is deleted.

NOTE: Generally, the deleted element must be replaced by a link.

Entering a Link

Description



NOTE: Accessible only in **LD mode** / smart relay in **STOP** mode.

This section describes the procedures for performing the following operations:

- Entering/Modifying links between elements,
- Deleting links between elements,
- Replacing a link with a contact.

Entering/Modifying a Link

Links are entered exclusively using the round flashing cursor.

Step	Action
1	Place the flashing cursor at the required location. The navigation keys can be used to move the cursor in the direction of the arrows on the navigation keys ◀ ▼ ▲ ▶. Illustration: 
2	Press the Shift key to display the contextual menu. Illustration: 
3	Trace connections by simultaneously pressing the Shift key and the navigation keys: ← ↑ ↓ →. Shift and → to trace a connection to the position of the next contact or to the coil at the end of the line. Shift and ↑ ↓ to trace perpendicular connections to the previous or next line. NOTE: You cannot add a perpendicular connection between lines 120 and 121.
4	Release the Shift key to have access to the navigation keys: ◀ ▼ ▲ ▶.
5	Repeat the operation as many times as necessary to create a program.

Deleting a Link

To delete a link, simply:

- Place the cursor over the element to delete.
- Simultaneously press the **Shift** and **Del** (Menu/OK) keys.

Two scenarios are possible, depending on the position of the cursor at the time of the deletion:

- Cursor over a link: The link is deleted,
- Over an empty position of the line: The line is deleted.

Replacing a Link with a Contact

Refer to the element entry procedure (*see page 47*).

Entry of Function Block Parameters

Description

NOTE: Accessible only in **LD mode** / smart relay in STOP mode.

When entering a control diagram, the parameters of the configurable automation functions must be completed.

The automation functions with parameters are the following:

- Auxiliary relays (*see page 95*) (latching),
- Discrete Outputs (*see page 98*) (latching),
- Clocks (*see page 132*),
- Analog Comparators (*see page 127*),
- Timers (*see page 101*),
- Counters (*see page 110*),
- Fast counters (*see page 116*).

Accessibility of parameters

Function block parameter setting can be accessed:

- When entering the command diagram line,
- From the **PARAMETERS** menu if the block has not been padlocked.

Entering/Modifying Parameters of the Block

Parameters are entered in the same way, whatever the parameters screen:

Step	Action
1	Place the flashing cursor at the required function. When the function has parameters, Param appears in the contextual menu (when the Shift key is pressed). Illustration: 
2	Press and hold down the Shift key and press on Param (key ►). Result: The function's parameter screen appears.
3	Use the navigation keys to move to the cursor over the modifiable parameters: ◀ ▶.
4	Modify the value of the parameter using the + and - keys, holding down Shift .
5	Confirm the modifications by pressing Menu/OK , which will open the confirmation window. Confirm again by pressing the Menu/OK key to save.

Deletion and Insertion of Diagram Lines

Introduction

NOTE: In front panel programming with 240 lines, program memory is stored in two banks. One bank contains lines 1 to 120, and the other bank contains lines 121 to 240. You must do the program modifications in the first part (line 1 to 120) or in the last part (line 121 to 240) and save them before being able to modify the other part.

When the cursor moves from line 120 to 121, the front panel notifies you to save the modification (see picture below) and display the line 121. Then modification could be done on last part of the ladder.

When the cursor goes from line 121 to 120, the front panel notifies you to save the modification (see picture below) and display the line 120. Then modification could be done on first part of the ladder.

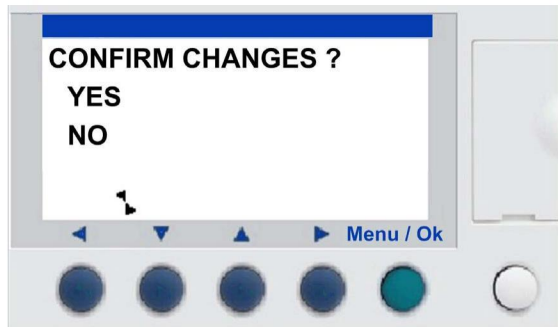

NOTE:

No link between the upper part (line 1 to 120) and the lower part (line 121 to 240) could be made in Ladder front panel programming:

- On line 120, it is not possible to insert a descending link (the descending link is displayed in the contextual menu but is ineffective).
- On line 121, it is not possible to insert an ascending link (the ascending link is displayed in the contextual menu but is ineffective).
- Insert a line in the upper part is possible only if line 120 is empty. If a line is inserted in upper part, the lower part is not modified.
- Delete a line in the upper part does not modify the lower part (line 121 does not move to line 120).

Deletion

NOTE: Accessible only in **LD mode** / smart relay in **STOP** mode.

Diagram lines are deleted line-by-line. The procedure is the following:

Step	Action
1	Place the cursor over the line to delete.
2	Delete all the elements in the line (<i>see page 47</i>): (Links, contacts and coils) to obtain an empty line.
3	Press the Shift key to display the contextual menu. Illustration: <div style="text-align: center; border: 1px solid gray; padding: 5px; width: fit-content; margin: 10px auto;"> ins. - + Del. ◀ ▼ ▲ ▶ Menu / OK </div> <p style="text-align: center;">Simultaneously pressing Shift and Del opens the confirmation window.</p>
4	Confirm by pressing Menu/OK .

NOTE: It is possible to delete all diagram lines contained in the smart relay. In order to do this, select the **CLEAR PROG.** option from the main menu, and confirm the deletion of all the control diagram lines.

Insertion

The procedure is the following:

Step	Action
1	Place the cursor over the line located immediately below the line to create.
2	Press the Shift key to display the contextual menu.
3	Press the Ins key (while holding down the Shift key) to create the line.

Chapter 5

PARAMETERS Menu

PARAMETERS Menu

Description

This menu is used to enter and modify the application parameters directly on the screen using the smart relay keys. This function can be accessed in the two modes: **LD** and **FBD**, but the contents will be specific to the mode used.

If there are non-locked parameters to display they are listed in the window; otherwise a **NO PARAMETER** message appears.

LD Mode

Functions with parameters in LD mode:

- Auxiliary relays (*see page 95*) (latching),
- Discrete Outputs (*see page 98*) (latching),
- Clocks (*see page 132*),
- Analog Comparators (*see page 127*),
- Timers (*see page 101*),
- Counters (*see page 110*),
- Fast counter (*see page 116*).

Only those functions used in the program and with parameters are listed in the **PARAMETERS** menu.

FBD Mode

Functions with parameters in FBD mode:

- Numerical Constant-Type Inputs,
- Clocks,
- Gain,
- Timers: TIMER A/C, TIMER B/H, TIMER Li,
- Counters: PRESET COUNT,
- Fast counter,
- CAM block.

To access the parameters of the FBD blocks, you must enter the block number. This number appears in the programming software on the wiring sheet at the top right corner of the block.

Only those functions used in the program and with parameters are listed in the **PARAMETERS** menu.

Parameter Modification

Parameter modification procedure:

Step	Action
1	Place the cursor over the PARAMETERS menu in the main menu (PARAMETERS flashing) and confirm by pressing the Menu/OK key. Result: The parameters window opens to the first parameter.
2	Select the function to modify. To access the required function, scroll through the function block numbers (navigation keys ▼ and ▲) until you reach the one to edit.
3	Select the parameter to modify. The ◀ and ▶ keys are used to place the cursor over the parameter to modify.
4	Modify the parameter using the + and - keys (▲ and ▼) of the contextual menu.
5	Confirm the modifications by pressing Menu/OK , which will open the confirmation window.
6	Confirm again twice by pressing Menu/OK to save. Result: The display returns to the INPUTS-OUTPUTS screen in RUN mode and to the MAIN menu in STOP mode.

Parameters in RUN Mode

It is possible to modify parameters in RUN mode as long as they are not locked.

The modifications can be made:

- From the **PARAMETERS** (*see page 55*) menu,
- From the **MONITORING** (*see page 57*) (LD) menu: Move the pointer over the function to be modified using the navigation keys and open the parameters window from the contextual menu (**Shift** key).

Chapter 6

MONITORING Menu

MONITORING Menu

Description

NOTE: Accessible only in LD mode / smart relay in RUN mode.

MONITORING mode can be used to obtain a dynamic view of the state of the smart relay inputs/outputs.

In this mode the wiring grid appears as it does in the PROGRAMMING (*see page 43*) menu (smart relay in **STOP** mode), but appear in reverse video when inputs or outputs are activated (white on black background).

Illustration:



This mode is also used to dynamically modify the values of automation function parameters if these are not locked.

Parameter Modification

To modify the parameters, proceed as follows:

Step	Action
1	Use the navigation keys to move the cursor over the element to modify.
2	Hold down Shift key then press the Param key to open the parameter window.
3	Use the navigation keys to move to the cursor over the modifiable parameters: ◀ ▶ .
4	Change the parameter value using the keys + and -.
5	Confirm the modifications by pressing Menu/OK , which will open the confirmation window. Confirm a second time by pressing Menu/OK to save.
6	Confirm again with Menu/OK . Result: Return to the parameter screen.
7	Confirm again with Menu/OK . Result: Return to the LD diagram screen.

Chapter 7

RUN/STOP Menu

RUN/STOP Menu

Description

This function is used to start or stop the program in the smart relay:

- In **STOP** mode: The program is stopped and the outputs disabled,
- In **RUN** mode (with or without initialization of latching parameters): The program is executed.

NOTE: The outputs of an extension SR3XT43BD are not disabled if an acceleration time is specified in the extension parameters.

Startup

In **STOP** mode, when accessing the **RUN/STOP** menu, the interface proposes the following three choices for starting the program:

- **WITH NONVOLAT INI:** All values (counters, timers, etc.) are reset to their initial values before the program starts (default selection),
- **NO NONVOLAT INI:** Values for which the **Latching** option has been activated are kept,
- **NO:** The program does not start.

Illustration:

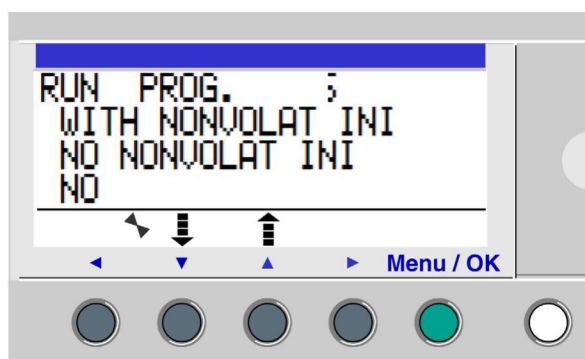

The navigation keys **▼ ▲** are used to change the selection.

When the setting has been validated with the **Menu/OK** key, the display moves to the **INPUT-OUTPUT** screen.

Off

In RUN mode, when accessing the RUN/STOP menu, you need to confirm the request to stop the program:

- **YES:** The program stops (selected by default),
- **NO:** The program does not stop.

Illustration:

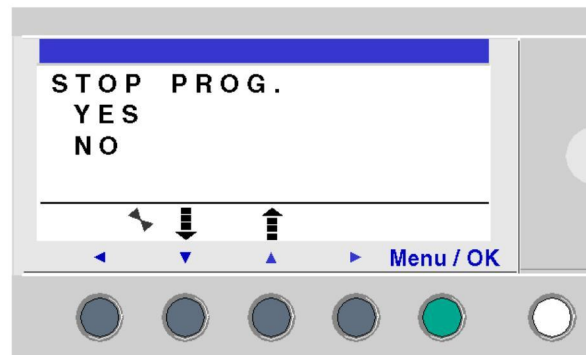

The navigation keys **▼ ▲** are used to change the selection.

When the setting has been confirmed with the **Menu/OK** key, the display moves to the **INPUT-OUTPUT** screen.

Smart Relays Without Screen

For smart modules without screen, a green LED located on the front panel of the module is an indicator light:

- If the LED flashes slowly (3 Hz), the module is in RUN mode (even if there is a recoverable error detected).
- If the LED flashes rapidly (5 Hz), the module is in STOP mode with an error detected.
- If the LED stays illuminated, the module is powered-up and in STOP mode.

NOTE: On power up, the smart relay is in RUN mode, unless there is an error detected.

NOTE: When an error has been detected, eliminate the source of the error and power cycle the module.

Chapter 8

CONFIGURATION Menu

Subject of this Chapter

The CONFIGURATION menu provides access to the following 4 functions:

- PASSWORD,
- FILTER,
- Zx KEYS,
- WATCHDOG & CYCLE

This chapter describes the characteristics of these functions.

NOTE: Use the navigation key to return to the main menu ◀.

NOTE: If the program is password-protected, (key displayed in the contextual menu), the user must enter the password before any action can take place in the sub-menus.

NOTE: The CONFIGURATION menu is only available in STOP mode.

What Is in This Chapter?

This chapter contains the following topics:

Topic	Page
PASSWORD Menu	62
FILTER Menu	65
Zx KEYS Menu	66
WATCHDOG CYCLE Menu	67

PASSWORD Menu

Description

If the program is password-protected (key icon appears), you must enter the password to perform certain operations.

The password protects access to the following menus:

- PROGRAMMING (LD STOP mode),
- MONITORING (LD RUN mode),
- CONFIGURATION (STOP mode),
- CLEAR PROG. (LD STOP mode),
- MODULE TRANSFER > MEM (STOP mode).
- MEM TRANSFER > MODULE (STOP mode). In LD mode, password protection of this menu is configurable.

NOTE: If you lose a password, you can overwrite the program from the programming software; see the on-line help of the programming software.

NOTE: It is possible to quit the screen without entering a password. Hold down **Shift** key (white key) then press the **Menu/OK** key (green key).

NOTE: To return to the main menu from the **CONFIGURATION** menu, use the navigation key ◀.

Defining Password

Initially, the key is not displayed and each digit is set to 0.

The **ENTER** message appears in the window.

Illustration:

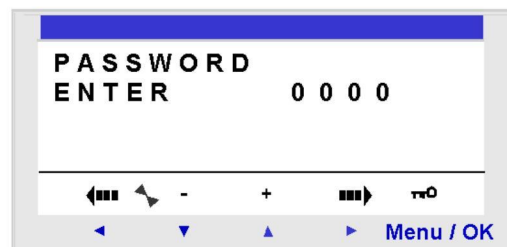

Entry procedure:

Step	Action
1	Use the navigation keys to select the digit to enter: ◀ ▶.
2	Select the value of the digit using the + and - keys of the contextual menu.
3	Confirm the password with the Menu/OK key, which opens the confirmation window.
4	Confirm again with the Menu/OK key. Result: The display returns to the MAIN menu.

NOTE: Henceforth the key is displayed in the contextual menu line.

Removing Password

To inhibit the password, follow the same procedure used to enter it.

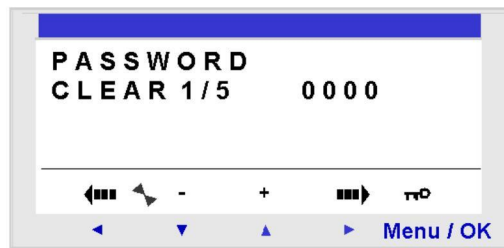

Initially, the key icon is displayed, meaning: Smart relay protected.

The message **CLEAR** and the number of attempts **1 / 5** appear in the window.

The following scenarios may arise:

- **Password correct:** The password is then inhibited, and the smart relay returns to the **PASSWORD** menu,
- **Password incorrect:** The **CLEAR** counter is incremented.

Illustration:

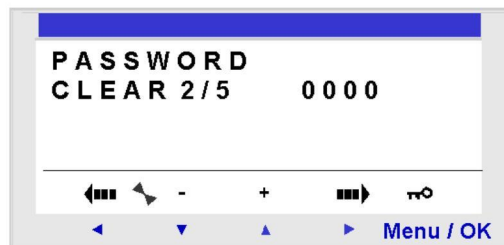

CONFIGURATION Menu

If an incorrect password is entered 5 times consecutively, the security function is locked for 30 minutes.

During this period, if the power supply to the smart relay is interrupted, the countdown will start again on power up.

Illustration:

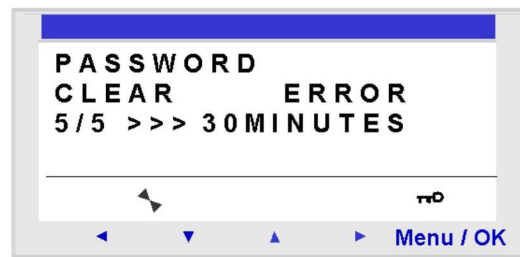

Modifying Password

To modify the password, remove the password and then enter a new one.

FILTER Menu

Description

This function is used to set the filter time of the inputs. A fast filter detects an input signal change faster than a slow filter; however, a fast filter is more sensitive to disturbances such as signal bounce.

Two choices are available:

- Fast
- Slow

Response time:

Filtering	Commutation	Response time
Slow	ON → OFF	5 milliseconds
	OFF → ON	3 milliseconds
Fast	ON → OFF	0.5 milliseconds
	OFF → ON	0.3 milliseconds

This selection can only be made when the smart relay is in STOP. By default, the smart relays are configured in SLOW.

NOTE: This function is available on smart relays with a direct voltage power supply.

NOTE: To return to the main menu from the CONFIGURATION menu, use the navigation key ◀.

Filter-Type Selection

The type is indicated by the selection symbol (black diamond).

Procedure for selection of filter type:

Step	Action
1	Select the type of filtering using the ▼ ▲ keys (the selection will flash).
2	Confirm with Menu/OK . Result: the display returns to the MAIN menu.

Zx KEYS Menu

Description

NOTE: Only accessible in LD mode.

The **Zx KEYS** option is used to activate or deactivate the use of the navigation keys as pushbuttons.

Different functions can be obtained depending on the state of this option:

- **Inactive:** The keys are only available for setting, configuring and programming the smart relay.
- **Active:** they can also be used in a control diagram.
In this configuration, they operate as pushbuttons: Zx keys (*see page 93*), without the need to use a terminal input contact.

NOTE: To return to the main menu from the CONFIGURATION menu, use the navigation key ◀.

Zx Keys in RUN Mode

By default, the Zx keys are used as navigation keys.

In RUN mode, when the inputs-outputs screen, TEXT screen or DISPLAY screen is active, the numbers of the Zx keys used in the program are displayed in the contextual menu line.

To activate the key, simply select the required key ◀ ▼ ▲ ▶.

Illustration:



NOTE: The function is inactive in Parameters mode, Monitoring and all the function block parameter and configuration screens.

WATCHDOG CYCLE Menu

Description

The duration of a program cycle depends on its length and complexity; in particular, the type and number of I/O and the number of extensions.

The program is executed periodically at regular time intervals. This time interval is called the cycle time.

The program will only execute completely if the cycle time is greater than the program execution time.

The cycle period is configurable in the **CONFIGURATION → WATCHDOG CYCLE** menu. This period may be set from 6 to 90 milliseconds in 2-millisecond steps.

The default value of the cycle period is 14 milliseconds.

Illustration:

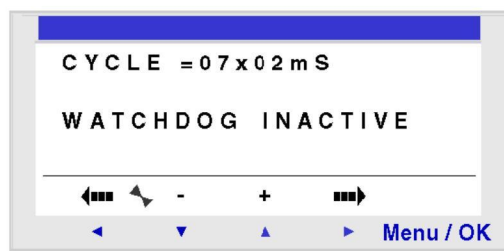

NOTE: Make sure that:

- Input variations that are too rapid are not hidden by a cycle time that is too slow.
- The speed of output variations is compatible with system commands.

If the duration of the execution cycle of the program and the embedded software functions exceeds the cycle time value selected by the programmer, the WATCHDOG can be used to operate a specific action.

NOTE: In certain dialog phases, the cycle times are increased by the communication times between the PC and the smart relay. The real cycle times vary greatly during this operating mode. The WATCHDOG is always inhibited in this smart relay operating mode.

NOTE: To return to the main menu from the CONFIGURATION menu, use the navigation key ◀.

Actions

The WATCHDOG can perform the following actions:

- **INACTIVE:** Normal operation
- **ALARM:** An error condition is set and the error code corresponding to **Cycle time overrun** is accessible in the **DEFAULT** menu.
- **ERROR:** The program stops (STOP mode) and the error code corresponding to **Cycle time overrun** is accessible in the **DEFAULT** menu.

Cycle Time

The cycle time may be set from 6 to 90 milliseconds in 2-millisecond steps.

To adjust this period, adjust the 2-millisecond step multiplier factor using the + and - keys in the contextual menu. This factor is between 3 and 45.

CYCLE = 07 x 02 mS

The multiplier factor is adjusted depending on the shortest sampling period of the inputs.

WATCHDOG Configuration

Procedure:

Step	Action
1	Configure the CYCLE parameter using the + and - keys in the contextual menu.
2	Confirm the entry using one of the following keys: ◀ or ▶. Result: The CYCLE parameter is confirmed and the WATCHDOG parameter is selected (it flashes).
3	Configure the WATCHDOG parameter using the + and - keys in the contextual menu.
4	Confirm your changes by pressing the Menu/OK key. Result: The display returns to the MAIN menu.

Chapter 9

CLEAR PROGRAM Menu

CLEAR PROG Menu.

Description

NOTE: Accessible only in LD mode.

This function is used to clear the entire program.

NOTE: If the program is protected (key displayed), the user must enter the password (see *PASSWORD Menu, page 62*) before being able to delete the program.

Clearing the Program

On opening, NO is selected by default.

Procedure:

Step	Action
1	Select the YES choice using the navigation keys ▼ and ▲.
2	Confirm the clear command by pressing the Menu/OK key. Result: the display returns to the MAIN menu.

CLEAR PROGRAM Menu



Chapter 10

TRANSFER Menu

TRANSFER Menu

Description

This function is used to:

- Load the firmware and the application contained in the smart relay into the backup memory.
- load firmware and application from the backup memory to the smart relay.

This backup memory can then be used to load the firmware and the application into another smart relay.

Illustration:



NOTE: The backup memory is provided as an option.

NOTE: Insertion and extraction of the backup memory may be performed even when the smart relay is powered up.

For smart relays without screens, detection of the memory may only be performed on power up of the smart relay, if the memory is inserted when the smart relay is powered on, it will not be acknowledged.

NOTE: If the application is protected (key icon displayed), you must enter the password before being able to save the program.

NOTE: If an application is already present in the backup memory, it will be overwritten by the new transfer.

NOTE: It is not possible to directly transfer an application created with version V2 of the programming software from the SR2MEM01 memory to the smart relay if this latter contains version V3 firmware.

In this case, see what action you should take in the section Application incompatible with firmware on the smart relay ([see page 73](#)).

For more information about the compatibility of the memory cartridges, see Compatibility between the memory cartridges and the firmware on the smart relay (*see page 187*).

Module → Backup Memory Transfer

Procedure for transferring the application from the smart relay to the backup memory, for a smart relay with LCD and keyboard:

Step	Action
1	Insert the memory cartridge (SR2MEM02) into the slot provided.
2	Select the transfer type: ZELIO>MEMORY using the navigation keys ▼ ▲.
3	Confirm the transfer command with the Menu/OK key. (Enter the password if the program is password-protected).
4	Wait for the transfer to end. Display: > > MEMORY then TRANSFER. OK when it is completed.
5	Confirm again by pressing Menu/OK key to exit the menu. Result: The display returns to the INPUTS-OUTPUTS screen in RUN mode and to the MAIN menu in STOP mode.

NOTE: It is not possible to transfer the application from a smart relay without LCD or keyboard. You can transfer the module application to the PC using Zelio Soft.

Backup Memory → Module Transfer

The program transfer from one smart relay to another via a memory card is only possible between smart relays with the same reference.

Procedure for transferring the application from the backup memory to the smart relay, for a smart relay with LCD and keyboard:

Step	Action
1	Insert the memory cartridge (SR2MEM02) with the program to be transferred into the slot provided.
2	Select the transfer type: MEMORY>ZELIO using the navigation keys ▼ ▲.
3	Confirm the transfer command with the Menu/OK key.
4	Wait for the transfer to end. Display: > > MODULE then TRANSFER. OK when it is completed.
5	Confirm again by pressing Menu/OK to exit the menu. Result: the display returns to the INPUTS-OUTPUTS screen in RUN mode and to the MAIN menu in STOP mode.

Procedure for transferring the application from the backup memory to the smart relay, for a smart relay without LCD or keyboard:

Step	Action
1	Since the smart relay is not powered-on , insert the memory cartridge (SR2MEM02) into the slot provided.
2	Power up the smart relay. During the transfer, the LED display is off.
3	Wait for the transfer to end. During the transfer, the LED display is off, then at the end of the transfer the LED flashes.
4	<ul style="list-style-type: none"> • If the flashing is slow (3 Hz), the transfer has been successful, the smart relay is in RUN, remove the memory cartridge (SR2MEM02). • If the flashing is rapid (5Hz), the transfer has been unsuccessful due to incompatibility between the configuration necessary for the program to be transferred and that of the smart relay.

NOTE: When the smart relay is in STOP mode, the LED display is illuminated and does not flash.

Possible Errors

Below are the possible errors and, for each case, the messages that are displayed:

- Absence of backup memory
Error message:
TRANSFER ERROR: NO MEMORY
- Configurations of the hardware and program to transfer incompatible
Error message:
TRANSFER ERROR: CONFIG INCOMPAT (hardware or software reference numbers).

For more details, refer to the DEFAULT menu (*see page 79*) chapter.

Application incompatible with firmware on the smart relay

If the application stored in backup memory SR2MEM01 was created with a version of the programming software that is incompatible (*see page 187*) with the firmware of the target smart relay, proceed as follows:

Step	Action
1	Load the application from the backup memory to a smart relay with compatible firmware. NOTE: If no smart relay has a firmware that is compatible with the application, use the programming software version that was used to create the application to load a compatible firmware into the target smart relay.
2	Use the version of the programming software that was used to create the application to load it from the smart relay toward the PC.

Step	Action
3	Save the application uploaded in step 2.
4	Launch the latest version of the programming software.
5	Open the application saved in step 3. Result: The programming software converts the application.
6	Load the converted application and the associated firmware to the target smart relay.

Use of SR2MEM01 and SR2MEM02

On SR2MEM01, only the program is loaded whereas on SR2MEM02 the program and the corresponding firmware are loaded.

Consequently:

- With the SR2MEM01 memory cartridge, you can perform:
 - A smart relay to memory transfer if the version of the firmware on this relay is strictly lower than 3.09.
 - A memory to smart relay transfer if the program contained in the SR2MEM01 memory cartridge is loaded from a smart relay that has the same version of firmware as the smart relay to which you want to load the cartridge.
- With the SR2MEM02, memory cartridge, you can perform:
 - A smart relay to memory transfer if the version of the firmware on this relay is equal to or greater than 3.09.
 - A memory to smart relay transfer if the version of the firmware on the relay to which you want to load the cartridge is greater than 3.09.

For more information about the compatibility of the memory cartridges, see Compatibility between the memory cartridges and the firmware on the smart relay ([see page 187](#)).

Chapter 11

VERSION Menu

VERSION Menu

Description

This function is used to precisely identify the version of each system component:

- **MODULE:** smart relay reference,
- **HARDWARE:** hardware version,
- **FIRMWARE:** firmware version,
- **LD FUNC:** language functional level if LD language or
FBD FUNC: language functional level if FBD language.

Illustration:

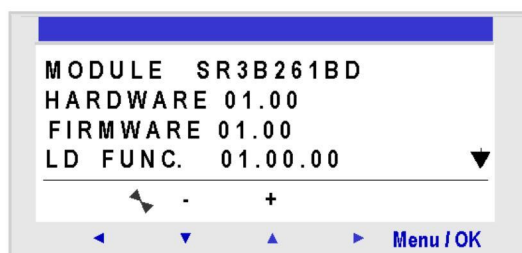

This information is available for the smart relay, but also for the connected extensions.

The ▼ symbol is present in the bottom right, indicating the existence of extensions connected to the smart relay.

VERSION Menu

Illustration:

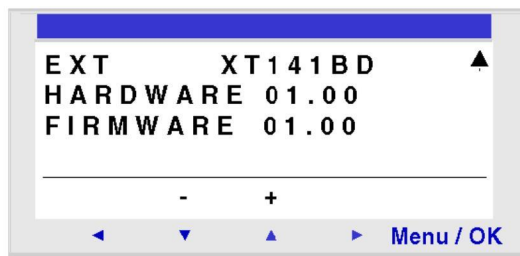

To quit, press the **Menu/OK** button, the display returns to the INPUTS-OUTPUTS screen if smart relay is in **RUN** mode and to the MAIN menu if smart relay is in **STOP** mode.

Chapter 12

LANGUAGE Menu

LANGUAGE Menu

Description

This function is used to select the language used by the smart relay.

All messages may be viewed in 6 languages:

- English,
- French,
- German,
- Italian,
- Spanish,
- Portuguese.

Illustration:

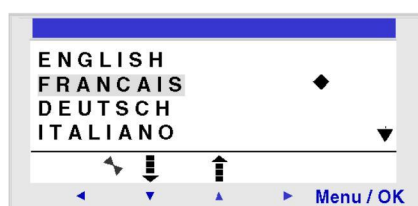

Language Selection

The current language is indicated by the selection symbol (black diamond).

Language selection procedure:

Step	Action
1	Select the language using the navigation keys: ▼ and ▲ (the selection flashes).
2	Confirm with the Menu/OK key. Result: The display returns to the INPUTS-OUTPUTS screen in RUN mode and to the MAIN menu in STOP mode.

Chapter 13

DEFAULT Menu

DEFAULT Menu

Description

This function is used to:

- Display on the LCD screen the type of error detected by the firmware of the smart relay (Watchdog overrun, *see WATCHDOG CYCLE Menu, page 67*, cycle time too high, etc.),
- Reset the error counter to zero.

Illustration:

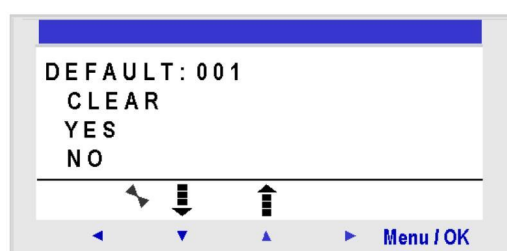

Reset to Zero of the Error Counter

To reset the error counter to zero, proceed as follows:

Step	Action
1	Select the YES choice using the navigation keys ▼ and ▲.
2	Confirm the clear command by pressing the Menu/OK key. Result: The display returns to the INPUTS-OUTPUTS screen in RUN mode and to the MAIN menu in STOP mode.

Error Types

Below, the description of possible errors:

Code	Type of error
000	No error
001	Error in writing to memory This error defines the transfer errors between the memory cartridge and the smart relay. If this error occurs frequently, contact your local Schneider Electric support representative.
002	Clock write error If the error occurs frequently, contact your local Schneider Electric support representative.
004	Overload on transistor outputs Once a transistor output reaches the threshold for over current detection, the group of 4 outputs to which it belongs is deactivated. To make this group of outputs operational, the cause of the over current (short-circuit, etc.) must first be deleted, and then the error cleared from the DEFAULT menu (<i>see page 79</i>).
050	Smart relay firmware is corrupted Reload the firmware on the smart relay and the user application. If this error persists, contact your local Schneider Electric support representative.
051	Watchdog overflow Advisory or error according to the selection made in the menu (smart relay display) or in the configuration window (programming software). The cycle time in the smart relay is too short compared with the application program execution time programmed in the smart relay. If the application requires cycle time or strict sampling of the smart relay inputs/outputs, lengthen the application cycle time in the smart relay. To do this, either set the parameters in the CONFIGURATION menu (smart relay display) or in the configuration window (programming software). If the application does not require a maximum cycle time, you must choose: No WATCHDOG Action in the CONFIGURATION menu.
052	The smart relay has executed an incorrect operation If the error is permanent, reload the firmware on the smart relay and the user application. If this error persists, contact your local Schneider Electric support representative.
053	Link error between smart relay and bus-type extension Verify operation of the extension (connection, power supply, error status).
054	Link error between smart relay and input/output-type extension Verify operation of the extension (connection, power supply and error status).
058	An error has been detected in the firmware (software specific to the smart relay) or on the smart relay hardware. If the error is permanent, reload the firmware on the smart relay and the user program. If this error persists, contact your local Schneider Electric support representative.

Code	Type of error
059	At the beginning of RUN on the smart relay application: The application cannot switch to RUN because it is incompatible with the smart relay physically connected to the power supply. If this error occurs, contact your local Schneider Electric support representative.
060	At the beginning of RUN on the smart relay application: Program incompatible with the bus extension physically connected to the power supply. If this error occurs, contact your local Schneider Electric support representative.
061	At the beginning of RUN on the smart relay application: Program incompatible with the Input/Output extension physically connected to the power supply. If this error occurs, contact your local Schneider Electric support representative.
062	Version (or build number) incompatibility when loading a program from the backup memory If this error occurs, contact your local Schneider Electric support representative.
063	Hardware configuration incompatibility when loading a program from the backup memory If this error occurs, contact your local Schneider Electric support representative.

DEFAULT Menu

Chapter 14

CHANGE DATE/TIME Menu

CHANGE DATE/TIME Menu

Description

This function is used to configure the date and time of the smart relays that have a clock.

Illustration:

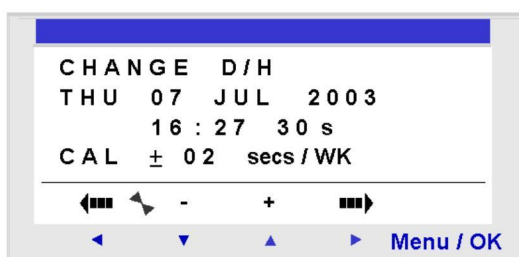

The modifiable parameters are:

- Day / week / month / year,
- Hour, minutes, seconds,
Values are recorded by pressing the **Menu/Ok** key.
- CAL: Calibration of the internal clock of the smart relay in seconds per week.

Clock Calibration

The quartz that controls the real-time clock of the smart relay has a variable monthly drift depending on the environmental conditions of the smart relay.

The maximum value for this drift is approximately one minute per month.

To estimate this drift, proceed by observing the drift on the smart relay clock with respect to a reference clock for a few weeks or more.

Example:

If you wish to compensate this drift, you can for example make a -15 second correction per week to compensate for a + 60 second drift per month. This compensation is executed on Sunday at 01:00.

NOTE: This correction serves no purpose if the smart relay is subject to long power interruptions or major variations in temperature.

Clock Configuration

Procedure:

Steps	Description
1	Select the parameter to modify using the navigation keys ◀ and ▶. Result: The selected parameter flashes.
2	Modify the value of the parameter. The + and - keys of the contextual menu can be used to change the current value.
3	Confirm the changes by pressing the Menu/Ok key. Result: The display returns to the MAIN menu.

NOTE: The smart relay determines the day of the week when the day of the month in the year is selected.

NOTE: You cannot modify the hour by a product between 2:00 and 3:00 for the days of the change from summer to winter time.

Chapter 15

CHANGE SUMMER/WINTER Menu

CHANGE SUMMER/WINTER Menu

Description

This function is used to change the time range automatically: Summer/winter, for smart relays with a clock.

Illustration:

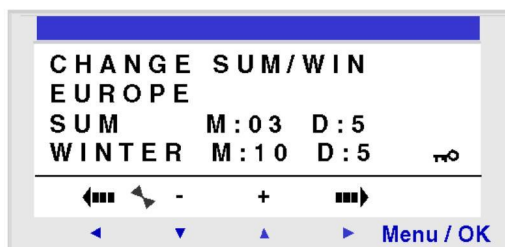

The following operating modes are possible:

- **NO:** no change,
- **Automatic:** The change takes place automatically, the dates are preset according to the geographic zone:
 - EUROPE: Europe,
 - USA.
- **OTHER ZONE: (MANUAL)** the change takes place automatically, but you must specify, for summer and winter:
 - The month: **M**,
 - The Sunday: **D** (1, 2, 3, 4 or 5) when the change takes place.

Configuration of the Time Change

To configure automatic time change, proceed as follows:

Step	Action
1	Select the parameter to modify using the navigation keys ◀ and ▶. Result: The selected parameter flashes.
2	Modify the parameter value. The + and - keys of the contextual menu are used to change the current value.
3	Confirm the changes by pressing the Menu/OK key. Result: The display returns to the MAIN menu.

Part III

LD Language

Chapter 16

LD Language Elements

Subject of this Chapter

This chapter describes the different automation functions of the LD language.

What Is in This Chapter?

This chapter contains the following topics:

Topic	Page
Introduction	90
Discrete Inputs	91
Zx Keys	93
Auxiliary Relays	95
Discrete Outputs	98
Timers	101
Counters	110
Fast Counter	116
Counter Comparators	125
Analog Comparators	127
Clocks	132
TEXT	135
LCD Screen Backlighting	137
Change to Summer / Winter Time	138
Modbus Inputs/Outputs	140
Message	141

Introduction

Description

In LD programming mode, an application can be created from the interface of the front panel of the smart relay.

Here is detailed information on the possible elements of a ladder diagram in LD mode that are recognized and used by smart relays.

To illustrate the functions performed by each element, where necessary a directly usable example is included.

Composition of Ladder Diagrams

The maximum number of lines in Ladder language that smart relays accept depends on two factors:

- the firmware version
- whether an SR2COM01 communication interface has been selected in the configuration.

For detailed information, refer to the table presented in Smart Relay Firmware Version Versus Functions (*see page 186*).

Each program line comprises of a maximum of 5 contacts. Contacts must be attached to one coil, and the coil is not necessarily on the same program line.

NOTE: When an application requires more than five contacts to activate an action, the auxiliary relays may be used.

NOTE: Perpendicular connection is not possible between the lines 120 and 121.

Sample Ladder Diagram

Below is an example of a ladder diagram, as it appears on the display of the front panel of a smart relay:

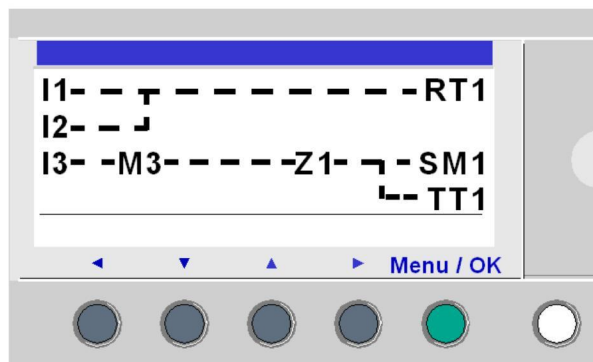

Discrete Inputs

Description

The **Discrete Inputs** can be used exclusively as contacts in the program.

These contacts represent the status of the input for the smart relay connected to a sensor (push button, switch, sensor, etc.).

The contact number corresponds to the number of terminals of the associated input: 1 to 9, then A to R (except for letters I, M and O) according to the smart relay and the possible extension.

Use as a Contact

This contact may use the direct state of the input (normally open contact) or its inverse state (normally closed contact), see below.

Normally open:

Symbol of a normally open contact:

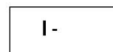

If the input is **supplied**, the contact is **conducting**.

Example:

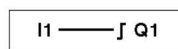

If input 1 is supplied, contact I1 is closed, and coil Q1 is activated.

Normally closed:

Symbol of a normally closed contact:

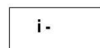

If the input is **supplied**, the contact is **non-conducting**.

Example:



If input 1 is supplied, contact i1 is open, and coil Q1 is not activated.

Modification of the state of a contact

To modify a contact from the front panel of the smart relay (the programming window is displayed on the screen):

- Place the cursor over the letter of the contact,
- Scroll through the possible contact types (I for a normally open contact, i for a normally closed contact).

For more details, refer to Method for Entering a Contact or Coil (*see page 47*).

Initialization

Status of contacts on program initialization:

- The direct state is inactive,
- The reverse state is active.

Zx Keys

Description

The navigation keys behave like the I physical inputs (Discrete inputs). The only difference is that they do not correspond to smart relay connection terminals, but to the four gray keys on the front panel.

They are used as pushbuttons, and can only be used as contacts.

Use as a Contact

This contact may use the direct state of the key (normally open contact) or its inverse state (normally closed contact), see below.

Normally open:

Symbol of the normally open contact, representing a key:

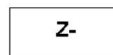

If the key is **pressed**, the corresponding input is **conducting**.

Normally closed:

Symbol of the normally closed contact, representing a key:

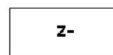

If the key is **pressed**, the corresponding input is **non-conducting**.

Example

Creating a switch operated by the Z1 key and Q1 output:

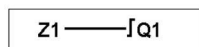

Each time the Z1 key is pressed, the Q1 output changes state.

Deactivation of Zx Keys

By default the **Zx Keys** are active. They may be deactivated as described here:

- From the smart relay front panel: Using **CONFIGURATION** → **Zx KEYS** menu, refer to Zx KEYS (*see page 66*)
- From the programming software: See on-line help of the programming software for more information.

NOTE: When the smart relay is in RUN mode, if the **Zx Keys** have been deactivated, they cannot be used for inputs in the program, but for navigating the menus.

Modification of the State of a Contact

To modify a contact from the front panel of the smart relay (the programming window is displayed on the screen):

- Place the mouse over the letter representing the contact,
- Scroll through the possible contact types (Z for a normally open contact, z for a normally closed contact).

For more details, refer to Method for Entering a Contact or Coil (*see page 47*).

Initialization

Status of contacts on program initialization:

- Normally open (direct state) is inactive,
- Normally closed (reverse state) is active.

Auxiliary Relays

Description

Auxiliary relays marked **M** or **N** behave as Discrete Outputs **Q** (*see page 98*), but do not have an electrical output contact. They can be used as internal variables.

NOTE: The maximum number of auxiliary relays depend on the firmware version and whether an SR2COM01 is included in the configuration (*see page 186*).

There are 28 **M** auxiliary relays, numbered from M1...M9, and then MA...MV, excluding MI, MM, and MO.

In addition, if no SR2COM01 communication interface has been selected in the configuration, there are 28 **N** auxiliary relays, numbered from N1...N9, and then NA...NV, excluding NI, NM, and NO.

The auxiliary relays can be used in the program, indifferently either as a coil or contact. They can be used to latch a state to be used in the form of the associated contact.

Use as a Coil

To use an auxiliary relay as a coil, 4 types are available:

- Direct coil
- Impulse coil
- Set (latch) coil
- Reset (Unlatch) coil

Direct coil:

Symbol of an auxiliary relay used as a Direct coil:

[M-

The relay is energized if the elements to which it is connected are conducting. Otherwise it is not energized.

Impulse coil:

Symbol of an auxiliary relay used as an Impulse coil:

J M-

Pulse energization, the coil changes state on each rising edge it receives.

Set coil:

Symbol of an auxiliary relay used as a Set coil:

SM-

The **SET** coil is energized as soon as the elements to which it is connected are conducting, then stays energized even if afterward the elements are no longer conducting.

Reset coil:

Symbol of an auxiliary relay used as a Reset coil:



The **RESET** coil is deactivated when the elements to which it is connected are conducting. It remains deactivated even if afterward the elements are no longer conducting.

NOTE: For upward compatibility for programs operating with Zelio 1, the four types of a given output coil (Q) or auxiliary relay (M) can be used in the same wiring sheet in Zelio 2.

Use as a Contact

Auxiliary relays can be used as contacts as many times as necessary.

This contact may use the direct state of the relay (normally open contact) or its inverse state (normally closed contact), see below.

Normally open:

Symbol of an auxiliary relay used as a contact in normally open:

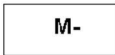

If the relay is **energized**, the contact is **conducting**.

Normally closed:

Symbol of an auxiliary relay used as a contact in normally closed:

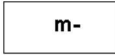

If the relay is **energized**, the contact is **non-conducting**.

Example

In the following example turning a lamp on and off is conditioned by the state of the 6 following inputs: I1, I2, I3, I4, I5, and IB.

The lamp is on when:

- Inputs I1, I4, I5, and IB are set to 1, and
- Inputs I2 and I3 are set to 0

As the smart relay does not allow more than five contacts on a line, auxiliary relays are used to control the lamp.

We have chosen to latch inputs I1, I4, I5, and IB using auxiliary relay M1 and to latch inputs I2 and I3 using auxiliary relay M2. The lamp is controlled by relays M1 and M2, which are used as a normally open contact and a normally closed contact respectively.

Illustration:

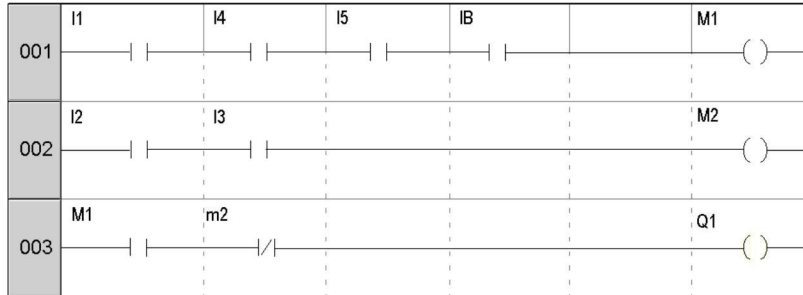

Modifying the State of a Coil or a Contact

To modify the type of a coil or a contact from the front panel of the smart relay (with the programming window displayed on screen):

- Position the cursor on the symbol representing the coil type or on the letter of the contact.
- Scroll through the possible coil or contact types (**M** for a normally open contact, **m** for a normally closed contact).

For more details, refer to Method for Entering a Contact or Coil ([see page 47](#)).

Initialization

State of contacts on program initialization:

- Normally open (direct state) is inactive.
- Normally closed (reverse state) is active.

Latching

By default, after a power outage, the relay is in the state that corresponds to program initialization.

To restore the state of the output as backed up before the power outage, latching must be activated:

- From the front panel: From the **PARAMETERS** ([see page 55](#)) menu, or
- In the programming software: Enable the **Latching** option in the parameters window associated with the relay.

Discrete Outputs

Description

Discrete Outputs correspond to the smart relay outputs (connected to the actuators). These outputs are numbered from Q1 to Q9, then from QA to QG, according to the smart relay reference and the connected extensions.

Discrete outputs can be used either with a coil (write) or a contact (read) element.

Use as a Coil

To use a Discrete output as a coil, four types are available:

- Direct coil
- Impulse coil
- Set (latch) coil
- Reset (Unlatch) coil

Direct coil:

Symbol of a Discrete output, used as a Direct coil:

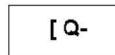

The coil is energized if the elements to which it is connected are conducting. Otherwise it is not energized.

Impulse coil:

Symbol of a Discrete output, used as an Impulse coil:

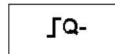

Pulse energization, the coil changes state on the rising edge of each pulse it receives.

Example: Switching a lamp on and off with a pushbutton:

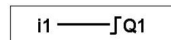

A push button is connected to input I1 and a lamp to output Q1. Every time the button is pressed, the lamp switches on or off.

Set coil:

Symbol of a Discrete output, used as a Set coil:

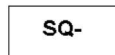

The Set coil is energized as soon as the elements to which it is connected are conducting, then stays energized even if afterward the elements are no longer conducting.

Reset coil:

Symbol of a Discrete output, used as a Reset coil:

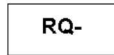

The **RESET** coil is deactivated when the elements to which it is connected are conducting. It remains inactive even if afterward the elements are no longer conducting.

Example: Switching a lamp on and off with two pushbuttons:

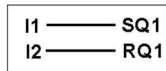

In this example, push button 1 (PB1) is connected to input I1. PBI2 to input I2. The lamp is controlled by output Q1. The lamp illuminates when pushbutton PBI1 is pressed, and it turns off when pushbutton PBI2 is pressed.

NOTE:

- Generally, an output is only used at one single point in the program as a coil (given the exception of the Set and Reset coils).
- If a SET coil is used for a Discrete output, provide a RESET coil for this output. The **RESET** coil takes priority over the **SET** coil.
The use of a Set coil on its own is only justified for activating an alarm signal that can be reset only by an INIT + ON action from the program.

Use as a Contact

An output can be used as a contact as many times as necessary.

This contact may use the direct state of the output (normally open contact) or its inverse state (normally closed contact), see below.

Normally open:

Symbol of a Discrete output, used as a contact in normally open:

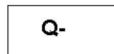

If the output is energized, the contact is conducting.

Normally closed:

Symbol of a Discrete output, used as a contact in normally closed:

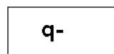

If the output is energized, the contact is non-conducting.

Modifying the State of a Coil or a Contact

To modify the type of a coil or a contact from the front panel of the smart relay (the programming window displayed on screen):

- Position the cursor on the symbol representing the coil output and press **Shift** key,
- Scroll through the possible coil or contact types (**Q** for a normally open contact, **q** for a normally closed contact).

For more details, refer to Method for Entering a Contact or Coil (*see page 47*).

Initialization

Status of contacts on program initialization:

- Normally open (direct state) is inactive,
- Normally closed (reverse state) is active.

Latching

By default, after a power outage, the outputs are in the state that corresponds to program initialization.

Activate latching to restore the state of the output as backed up before the power outage:

- From the front panel: from the **PARAMETERS** menu (*see page 55*), or
- In the programming software: Enable the **Latching** option in the parameters window associated with the output.

Timers

Description

Use the **Timers** function to delay, prolong and control actions over a predetermined period. Durations can be set using one or two preset values, according to the type of timer.

There are 11 types of timers:

- A: Active, control held down,
- a: Active, Press to start/stop,
- C: Off delay,
- B: On pulse one shot: Pulse calibrated on the command input rising edge,
- W: Timing after pulse: Pulse calibrated on the command input falling edge,
- D: Symmetrical flashing: control held down synchronously,
- PD: Symmetrical flashing, Start/stop on pulse,
- T: Time on addition,
- AC: A/C: Combination of A and C,
- L: Flasher unit, control held down asynchronously,
- I: Flasher unit; Press to start/stop.

For the description of different types of timers, refer to the Timing Diagrams ([see page 105](#)).

The smart relay has either 28 timer function blocks, or 16 timer function blocks if an SR2COM01 communication interface is present. They are numbered from 1...9 then from A...V (I, M, O are not used).

NOTE: The maximum number of timers also depends on the firmware version ([see page 186](#)).

Each block has a reset input, a command input and an output used to indicate timer time-out.

Use of Coils

Two coils are associated with each timer:

- Coil TT: Command Input,
- Coil RC: Reset Input,

The use of these coils is described below.

Command input:

Symbol of the Command input coil of a timer:



Each type involves a specific operation, which can be used to manage the possible scenarios in an application.

Reset input:

Symbol of the Reset input coil of a timer:



Energization of the coil causes a reset of the timer value: contact T is deactivated and the function is ready for a new timer cycle.

NOTE: This coil is only necessary for pulse start/stop type timers.

Use as a Contact

The contact associated with the timer indicates whether the timer has stopped.

It may be used as many times as necessary in the program either as normally open or as normally closed:

Normally open:

Symbol of the normally open contact associated with a timer:

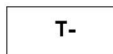

If the output of the Timer function block is **active**, the contact is **conducting**.

Normally closed:

Symbol of the normally closed contact associated with a timer:

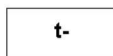

If the output of the Timer function block is **active**, the contact is **non-conducting**.

Configuration from Front Panel

The block parameter settings can be accessed either when entering the command line or from the **PARAMETERS** menu if the block has not been padlocked.

The parameters to enter are the following:

- Timer type,
- Preset value(s),
- Time unit,
- Parameter lock,
- Latching.

Type of timer:

This parameter allows you to choose the type of timer function from among the 11 types available. Each type is represented by one or two letters:

- A: Active, control held down,
- a: Active, Press to start/stop,

- C: Off delay,
- B: On pulse one shot: Pulse calibrated on the command input rising edge,
- W: Timing after pulse: Pulse calibrated on the command input falling edge,
- D: Symmetrical flashing: control held down synchronously,
- PD: Symmetrical flashing, Start/stop on pulse,
- T: Time on addition,
- AC: A/C: Combination of A and C,
- L: Flasher unit, control held down asynchronously,
- I: Flasher unit; Press to start/stop.

Preset value:

Depending on the type of timer, there can be 1 or 2 preset values:

- 1 preset value for the A, a, C, B, W, D, PD and T types:

: on-delay or off-delay according to type.

- 2 preset values for the AC, L and I types:

: Timer on-delay in the case of AC type; active state in the case of flasher units L and I.

: Timer off-delay in the case of AC type; inactive state in the case of flasher units L and I.

Time unit:

This is the time unit for the preset value. There are five possibilities:

Unit	Symbol	Form	Maximum value
1/100 of a second	<input type="text" value="s"/>	00.00 s	00.00 s
1/10 of a second	<input type="text" value="S"/>	000.0 s	00.00 s
Minutes : Seconds	<input type="text" value="M : S"/>	00 : 00	99 : 99
Hour : Minute	<input type="text" value="H : M"/>	00 : 00	99 : 99
Hours Only for type T.	<input type="text" value="H"/>	0 000 h	9,999 h

Parameter lock:

Symbol of the **Parameter Lock** parameter:



Locking prevents the modification of locked parameters from the front panel of the smart relay via the PARAMETERS menu.

Latching:

By default, if a power outage occurs while a timer function block is running, the information on time already elapsed is lost. When the supply voltage returns, the time function block is reinitialized and ready for a new operating cycle.

If the application requires it, the time elapsed before the power outage can be memorized using the **Latching** parameter.

Symbol of the **Latching** parameter:



This function is used to save the timer values and memorize the elapsed time in the event of a power outage.

Illustration: Configuring a counter from the front panel of the smart relay:

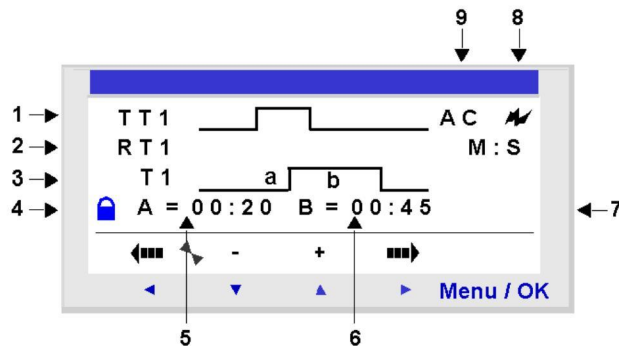

Description:

Number	Parameter	Description
1	Command input	Command input timing diagram.
2	Reset input	Reset input timing diagram.
3	Timer output	Timer output timing diagram.
4	Parameter lock 	This parameter is used to lock the counter parameters. When the block is locked, the preset value no longer appears in the PARAMETERS menu.

Number	Parameter	Description
5	Timer on-delay	Timer on-delay of the AC timer.
6	Timer off-delay	Timer off-delay of the AC timer.
7	Time unit	Time unit for the preset value.
8	Latching	Backup of counter value.
9	Timer type	Type of timer used.

Timing Diagrams

Timing diagrams are provided here to illustrate the various behaviors of the Timer function block, according to the selected type of timer:

Type A is Active, control held down. The following diagram shows the operation of the type A timer:



Type a is Active, Press to start/stop. The following diagram shows the operation of the type a timer:

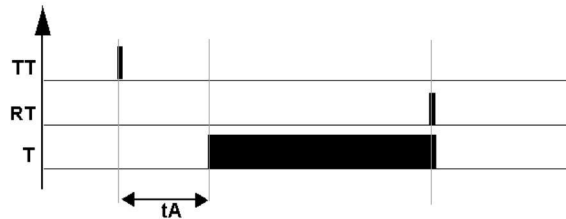

NOTE: Each rising edge on the TTx input resets the timer value to 0.

Type C is **Off delay**. The following diagram shows the operation of the type C timer:

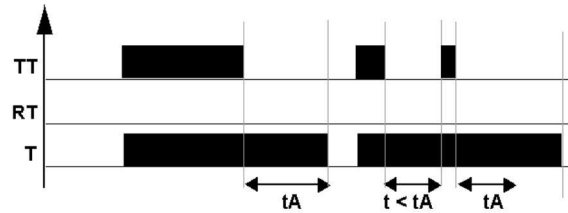

Type B is **On pulse one shot** for a pulse calibrated on the command input rising edge. The following diagram shows the operation of the type B timer:

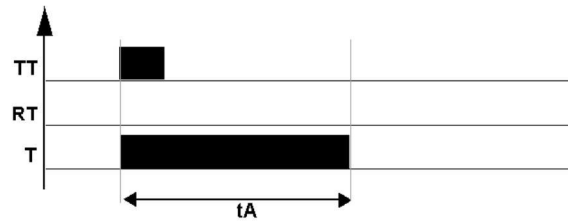

Type W is **Timing after pulse** for a pulse calibrated on the command input falling edge. The following diagram shows the operation of the type W timer:

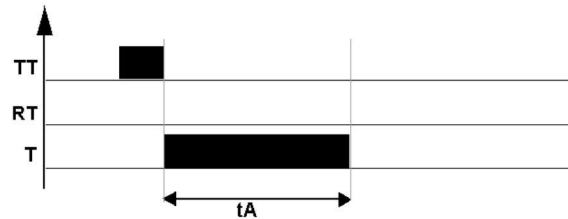

Type D is **Symmetrical flashing** for control held down synchronously. The following diagram shows the operation of the type D timer:

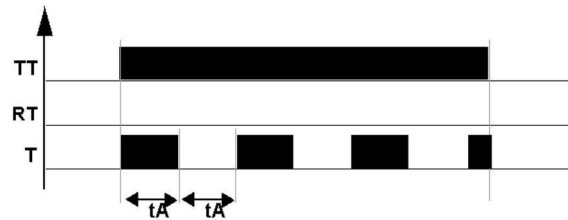

Type PD is **Symmetrical flashing, Start/stop on pulse**. The following diagram shows the operation of the type PD timer:



NOTE: Each rising edge on the TTx input resets the timer value to 0.

T is **Time on addition**. The following diagram shows the operation of the type T timer:

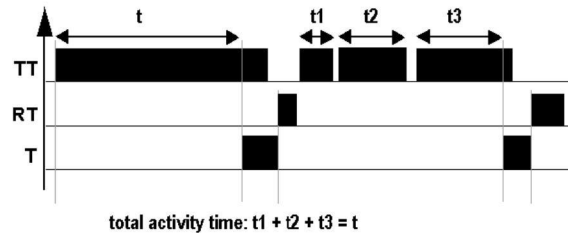

With this type, the preset value can be reached:

- In one step: t ,
- In several steps: $t_1 + t_2 + \dots + t_n$.

Type AC (A/C) is a combination of A and C. The following diagram shows the operation of the type AC timer:

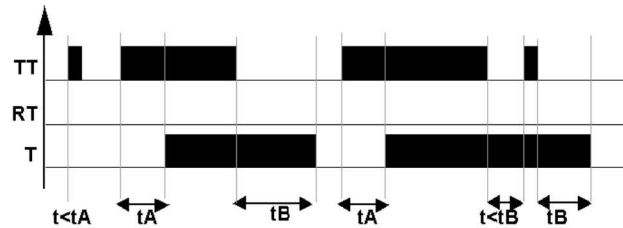

Type L is Flasher unit, control held down asynchronously. The following diagram shows the operation of the type L timer:

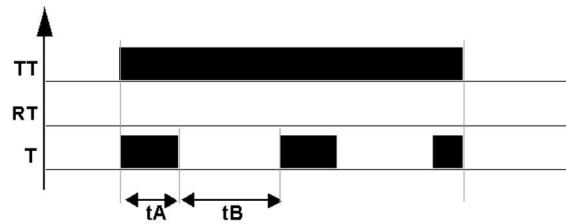

Type I is Flasher unit; Press to start/stop. The following diagram shows the operation of the type I timer:

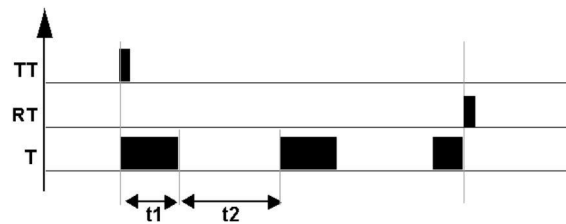

NOTE: Each rising edge on the TTx input resets the timer value to 0.

Modifying the State of a Coil or a Contact

To modify the type of a coil or a contact from the front panel of the smart relay (the programming window displayed on screen):

- Position the cursor on the symbol representing the coil type or on the letter of the contact,
- Scroll through the possible coil or contact types (T for a normally open contact, t for a normally closed contact).

For more details, refer to Method for Entering a Contact or Coil (*see page 47*).

Initialization

State of the contacts and values on initialization of the program:

- The normally open (direct state) is inactive,
- the normally closed (inverse state) is active,
- the value(s) is (are) zero(s).

Example 1

Creating a timer device for a stairway.

The stairway light should remain on for two minutes and thirty seconds when one of the push buttons is activated.

On each floor, the buttons are linked to the I1 input of the smart relay.

The stairway light is linked to the Q4 output of the smart relay.

You would write the following program:

```
I1-----TT1
I2-----RT1
T1-----[Q4
```

To obtain the desired operation, you should use a type B timer (On pulse one shot), and configure the duration of the timer for 2 minutes 30 seconds. To thus configure the timer duration, choose the time units M : S and enter the value 02:30 for the preset value t.

Illustration: Timer's configuration screen:

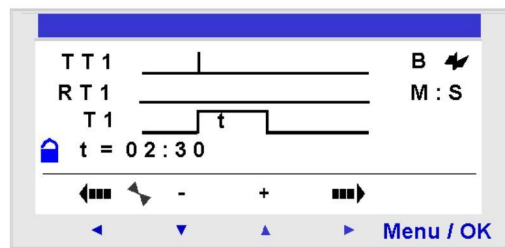

Counters

Description

The **Counters** function is used to upcount or downcount pulses. The smart relay has either 28 counters, or 16 counters if an SR2COM01 communication interface has been selected in the configuration. They are numbered from 1...9 then from A...V (I, M, O are not used).

NOTE: The maximum number of counters also depends on the firmware version (*see page 186*).

The **Counters** function can be reset to zero or to the preset value (depending on the chosen parameter) during use.

It may be used as a contact to find out whether:

- The preset value has been reached (upcounting **TO**),
- The counter has reached 0 (downcounting **FROM**).

Use of Coils

Each timer has 3 associated coils:

- Coil **CC**: **C**ounting **P**ulse **I**nput,
- Coil **RC**: **R**eset **I**nitial **C**ounter **S**tate **I**nput,
- Coil **DC**: **C**ounting **D**irection input.

The use of these coils is described below.

Counting pulse input:

Symbol of the Counting Pulse Input coil of a timer:

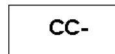

When used as a coil in a control diagram, this element represents a counting input for the function. Every time the coil is energized, the counter is incremented or decremented by 1 according to the counting direction chosen.

Example: Input counting pulses delivered by counter no. 1.

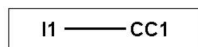

Every time input I1 is energized, the counter no. 1 is incremented by 1.

Reset Initial Counter State input:

Symbol of the Reset Initial Counter State Input coil:



When used as a coil in a control diagram, this element represents an input that resets the counting function to its initial state.

Energizing the coil has the following effect:

- Reset the count value to **zero** if the count type is **TO** (upcounting to the preset value),
- Reset the value to the **preset value** if the count type is **FROM** (downcounting from the preset value).

Example: Counter no. 1 reset to zero by pressing Z1 key.

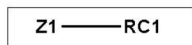

Every time key Z1 is pressed, the counter starts from 0.

Counting direction input:

Symbol of the Counting Direction Input coil of a timer:



This input determines the counting direction according to its status:

- It downcounts if the coil is energized,
- It upcounts if the coil is not energized.

NOTE: By default, if this input is not wired, the function upcounts.

Example: Up/downcounts, depending on the status of smart relay input I2.

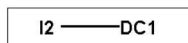

If the I2 input is active, the function downcounts.

Use as a Contact

The contact associated with the counter indicates whether the preset value (**TO**) or zero (**FROM**) has been reached.

It may be used as many times as necessary in the program either as normally open or as normally closed:

Normally open:

Symbol of the normally open contact associated with a counter:

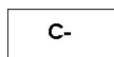

The contact is **conducting when:**

- The counter value **has reached** the preset value, if the counter is upcounting (**TO**).
- The counter value is **equal to 0**, if the counter is downcounting (**FROM**).

Normally closed:

Symbol of the normally closed contact associated with a counter:

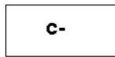

The contact is **conducting as long as**:

- The counter value **has not reached** the preset value, if the counter is upcounting (**TO**).
- The counter value **is not equal to 0** if the counter is downcounting (**FROM**).

Example: Lighting a LED connected to counter no. 1 output (**TO**).

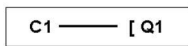

When the preset value has been reached: The LED is illuminated; otherwise it is off.

Configuration from Front Panel

The block parameter settings can be accessed either when entering the command line or from the **PARAMETERS** menu if the block has not been padlocked.

The parameters to enter are the following:

- Type of counting,
- Preset value,
- Parameter lock,
- Latching.

Type of counting:

Symbol of the type of counting parameter:



This parameter is used to select the type of the counter:

- **TO:** upcounting towards the preset value.
When the counter value is equal to the preset value, contact C of the counter is conducting.
- **FROM:** downcounting from the preset value.
When the counter value equals 0, counter contact C is conducting.

Preset value:

Symbol of the preset value parameter:

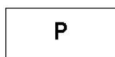

This value is between 0 and 32,767, and represents:

- The value to reach when counting to the preset value (**TO**),
- The initial value when downcounting from the preset value (**FROM**).

Parameter lock:

Symbol of the Parameter lock parameter:



Locking prevents the modification of locked parameters from the front panel of the smart relay via the PARAMETERS menu.

Latching:

Symbol of the Latching parameter:



This function is used to save the status of the counter values in the event of a power outage.

Illustration: Configuring a counter from the front panel of the smart relay:

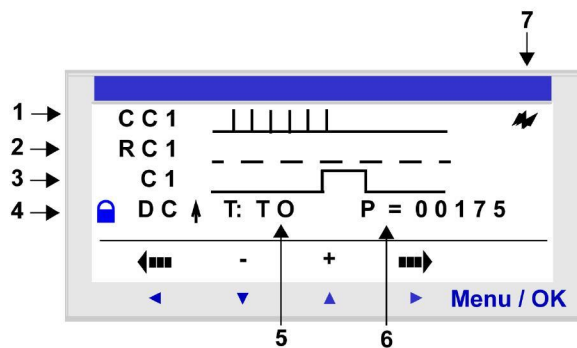

Description:

Number	Parameter	Description
1	Command input	Control input timing diagram (following pulse).
2	Reset input	Counter reset input timing diagram.
3	Counter output	Counter output timing diagram.
4	Parameter lock 	This parameter is used to lock the counter parameters. When the block is locked, the preset value no longer appears in the PARAMETERS menu.
5	Type of counting	TO: upcounting towards the preset value or, FROM: downcounting from the preset value.
6	Preset value	Counter preset value.
7	Latching	Backup of the counter value.

Counter Value

The counter value is the value at a given time resulting from the successive up/down counting actions that have occurred since the last time the counter was reset to its initial state.

This value is between 0 and 32767. Once these limits have been reached, a downcount will leave the value 0 and an upcount will leave the value at + 32767.

Timing Diagrams

In the timing diagrams, the blue curves represent the value of the counter:

The following figure shows the operation of the counter when upcounting (TO) toward the preset value:

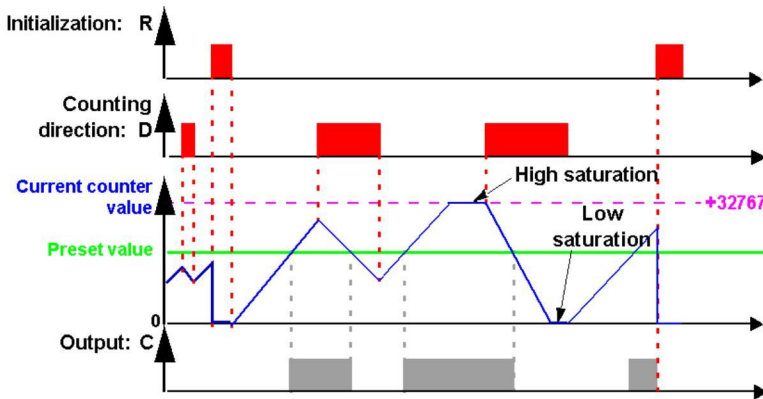

The following figure shows the operation of the counter when downcounting (FROM) from the preset value:

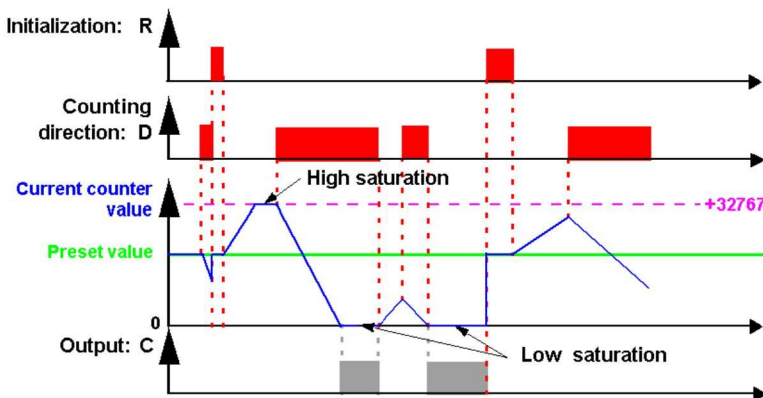

Modifying the State of a Coil or a Contact

To modify the type of a coil or a contact from the front panel of the smart relay (the programming window displayed on screen):

- Position the cursor on the symbol representing the coil type or on the letter of the contact,
- Scroll through the possible coil or contact types (**C** for a normally open contact, **c** for a normally closed contact).

For more details, refer to Method for Entering a Contact or Coil (*see page 47*).

Initialization

Status of the contacts and value on initialization of the program:

- The **normally open** (direct state) is **inactive**,
- The **normally closed** (inverse state) is **active**,
- The **value** is **zero**.

Examples

Below, three examples of the use of a counter:

Screen	Description
<pre> I1-----CC1 I2-----RC1 </pre>	<p>Upcounting and zero resetting: The counter is incremented each time input I1 is activated. The counter is reset each time input I2 is activated.</p>
<pre> I1-----GC1 DC1 I2-----RC1 </pre>	<p>Downcounting and Resetting: The counter is decremented each time input I1 is activated. The counter is reset each time the I2 input is activated.</p>
<pre> I1-----CC1 I3-----DC1 I2-----RC1 </pre>	<p>Upcounting, Downcounting and Resetting: The counter is incremented each time input I1 is activated. The counter is decremented each time the I3 input is activated. The counter is reset each time the input I2 is activated.</p>

Fast Counter

Description

The **Fast Counter** function is used to count pulses up to a frequency of 1 kHz.

Use of the **K1** contact indicates:

- The preset value has been reached (upcounting),
- The value 0 has been reached (downcounting).

The **Fast counter** inputs are implicitly connected to the **I1** and **I2** smart relay inputs:

- A pulse (rising edge) on the **I1** input increments the counter,
- A pulse (rising edge) on the **I2** input decrements the counter.

These inputs cannot be used in any other context.

The **Fast Counter** function can be reset to zero during use by the **RK1** coil. It is reset to:

- 0 if it is upcounting towards the preset value
- the preset value if it is downcounting from the preset value.

The counter only operates if the **TK1** confirmation coil is active.

Repetitive cycle type can be used with a time-delay value.

NOTE: Limit overrun:

- If the value of the counter exceeds the upper limit: **+ 32,767**, it is set to **- 32,768**,
- if the value of the counter exceeds the lower limit: **-32,768**, it is set to **+32,767**.

NOTE: This function block cannot be simulated.

Use of Coils

Two coils are associated with the fast counter:

- coil **TK1**: **Enable function input**,
- coil **RK1**: **Reset initial counter state input**.

The use of these coils is described below.

Enable function input:

Symbol of the Enable Function Input coil of the fast counter:

TK1

This element is used to confirm the counter. When this coil is active, each rising edge on the **I1** input will increment the **Fast counter** and each rising edge on the **I2** input will decrement it.

Reset initial counter state input:

Symbol of the Reset Initial Counter State Input:



This input resets the counter function to its initial state.

Energizing the coil has the following effect:

- reset the counter value to **zero** if the **count type** is **TO** (upcounting to the preset value).
- reset the counter value to the **preset value** if the count type is **FROM** (downcounting from the preset value).

Example: Counter reset by pressing on the Z1 key:

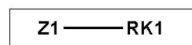

Each time the Z1 key is pressed, the counter is reinitialized.

Use as a Contact

The contact associated with the fast counter indicates whether the preset value (**TO**) or zero (**FROM**) has been reached.

It may be used as many times as necessary in the program either as normally open or as normally closed:

Normally open:

Symbol of the normally open contact associated with the fast counter:

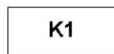

The contact is **conducting when**:

- the value of the counter has **reached the preset value (TO)**,
- the value of the counter has **reached 0 (FROM)**.

Normally closed:

Symbol of the normally closed contact associated with the fast counter:

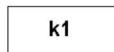

The contact is **conducting as long as**:

- the counter value **has not reached** the preset value, if the counter is upcounting,
- the counter value **has not reached 0**, if the counter is downcounting,

Example: Lighting a LED connected to fast counter no. 1 output (TO).

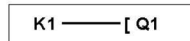

When the preset value has been reached: The LED is illuminated; otherwise it is off.

Configuration from Front Panel

The block parameter settings can be accessed either when entering the command line or from the **PARAMETERS** menu if the block has not been padlocked.

The parameters to enter are the following:

- Cycle type,
- Duration of pulse,
- Preset value,
- Type of counting,
- Parameter lock,
- Latching.

Cycle type:

This parameter determines the behavior of the fast counter when it reaches the preset value (when upcounting **TO**), or when it reaches the value zero (when downcounting **FROM**):

The cycle type may be:

- **Single:** Reaching the preset value (when upcounting **TO**) or the zero value (when downcounting **FROM**) does not affect the value of the counter.
The counter value changes on an on-going basis. The output is activated when the value is greater than the preset value (when upcounting **TO**) or when it is less than the preset value (when downcounting **FROM**).
- **Repetitive:** when upcounting **TO**, the value is reinitialized when it reaches the preset value and when downcounting **FROM**, it is reset to the preset value when it reaches zero.
The output is enabled following this reinitialization and remains active for a time that may be configured with the parameter: **Duration of pulse** (from 1 to 32,767 times 100 ms).

Duration of pulse:

Symbol of the **Duration of pulse** parameter:

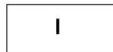

This parameter is only displayed if the cycle is repetitive. It determines the duration during which the fast counter remains active when the value reaches the preset value (when upcounting **TO**), or when it reaches the value zero (when downcounting **FROM**).

This value must be between 1 and 32,767 (x 100 ms).

Preset value:

Symbol of the **Preset value** parameter:



This value is between 0 and 32,767, and represents:

- the value to reach when upcounting to the preset value (**TO**),
- the initial value when downcounting from the preset value (**FROM**).

Type of counting:

Symbol of the **Type of counting** parameter:



This parameter is used to select the type of the counter:

- **TO**: upcounting towards the preset value.
When the counter value is greater than or equal to the preset value, contact K1 of the fast counter is conducting.
- **FROM**: downcounting from the preset value.
When the counter value is less than or equal to 0, contact C of the counter is conducting.

Parameter lock:

Symbol of the **Parameter Lock** parameter:



Locking prevents the modification of locked parameters from the front panel of the smart relay via the PARAMETERS menu.

Latching:

Symbol of the **Latching** parameter:



This function is used to save the status of the fast counter values in the event of a power outage.

Illustration: configuring a counter from the front panel of the smart relay:

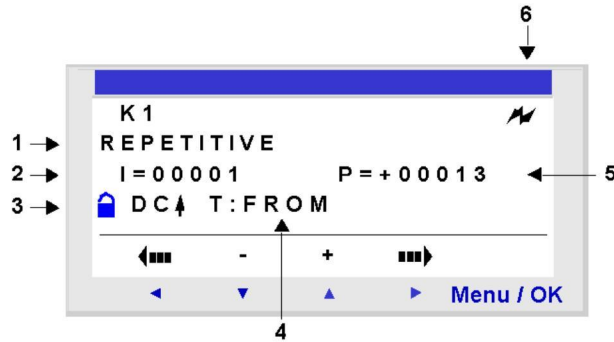

Description:

Number	Parameter	Description
1	Cycle type	Single/Repetitive
2	Duration of pulse	Only if the cycle is repetitive
3	Parameter lock 	This parameter is used to lock the counter parameters. When the block is locked, the preset value no longer appears in the PARAMETERS menu.
4	Type of counting	Counter configuration: Counting to the preset value (TO) or from the preset value (FROM).
5	Preset value	Counter preset value.
6	Latching	Backup of the counter value.

Counter Value

Value at a given instant resulting from successive up/down counts since the last counter reset to its initial state.

If the value of the counter exceeds the upper limit: +32,767, it is set to -32,768.

If the value of the counter exceeds the lower limit: -32,768, it is set to +32,767.

Timing Diagrams

Timing diagrams are provided here to illustrate the various behaviors of the fast counter according to its parameters:

- upcounting function **TO**, in single cycle type,
- downcounting function **FROM**, in single cycle type,
- upcounting function **TO**, in repetitive cycle type,
- downcounting function **FROM**, in repetitive cycle type.

For the following 4 charts, the blue curve represents the value of the counter. When it increases, it is because of pulses on I1 and when it decreases, it is because of pulses on I2.

UpCounting in Single Cycle Type:

The figure below illustrates the counter function in upcounting and single cycle type:

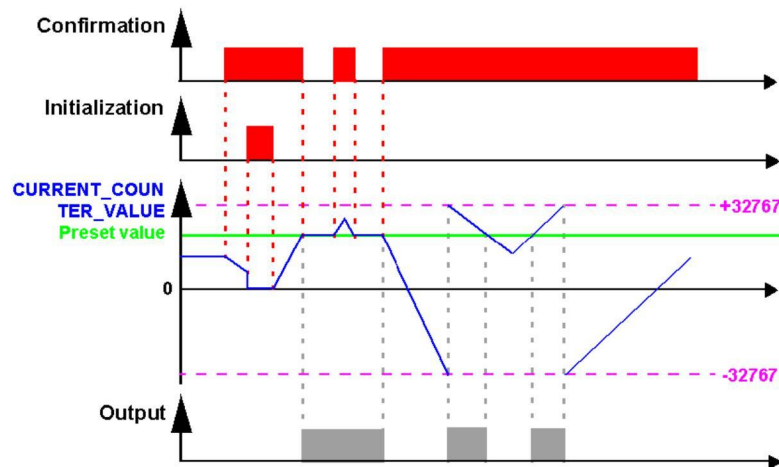

Downcounting in Single Cycle Type:

The figure below illustrates the counter function in downcounting and single cycle type:

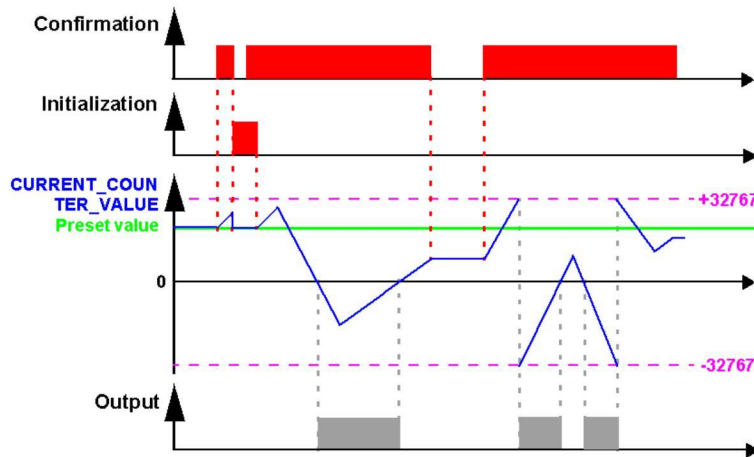

Upcounting in Repetitive Cycle Type:

The figure below illustrates the counter function in upcounting and repetitive cycle type:

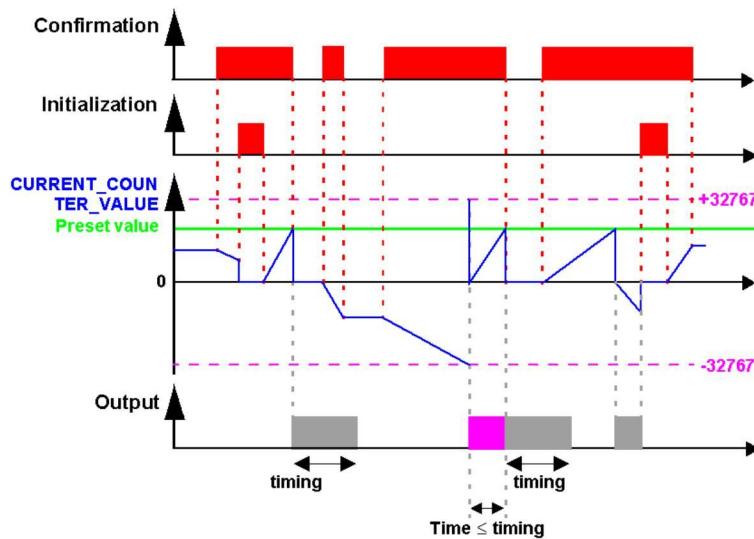

The output switches to the Inactive state when the predefined pulse duration value has elapsed. If the switch condition is Active before the switch to the Inactive state, the output pulse is extended by the Duration of pulse (Timing).

Downcounting in Repetitive Cycle Type:

The figure below illustrates the counter function in downcounting and repetitive cycle type:

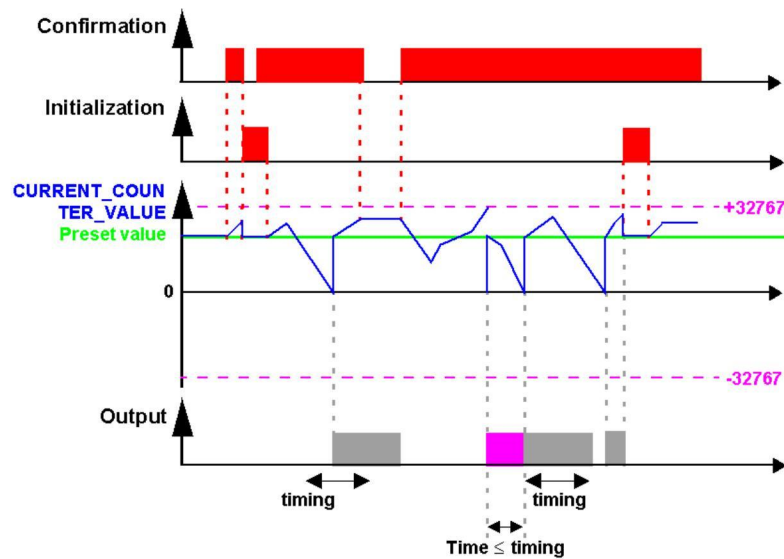

The output switches to the **Inactive** state when the predefined pulse duration value has elapsed. If the switch condition is Active before the switch to the Inactive state, the output pulse is extended by the Duration of pulse (Timing).

Modifying the State of a Coil or a Contact

To modify the type of a coil or a contact from the front panel of the smart relay (the programming window displayed on screen):

- Position the cursor on the symbol representing the coil type or on the letter of the contact,
- Scroll through the possible coil or contact types (K for a normally open contact, k for a normally closed contact).

For more details, refer to Method for Entering a Contact or Coil (*see page 47*).

Initialization

Status of the contacts and value on initialization of the program:

- The normally open (direct state) is **inactive**,
- the normally closed (inverse state) is **active**,
- The value is **zero**.

Example

Below, an example of using a fast counter: output Q1 is set to 1 when the fast counter is set to 1; the counter is activated by input I3 and reset to 0 by input I4.

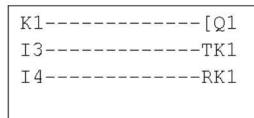

Counter Comparators

Description

This function is used to compare the values of two counters or of a counter and a constant value.

NOTE: The **Counter Comparators** function block can only be configured from the programming software in **Ladder Entry**.

See on-line help of the programming software for more information.

Use as a Contact

The counter comparator indicates whether the chosen condition is verified. It is used as a contact, in normally open or in normally closed.

Normally open:

Symbol of the counter comparator, in normally open:

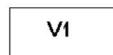

The contact is **conducting** when the condition is **verified**.

Normally closed:

Symbol of the counter comparator, in normally closed:

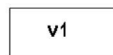

The contact is **conducting** when the condition is **not verified**.

Configuration from the Front Panel

The **Counter Comparators** function block cannot be configured from the front panel of the smart relay. This function must be configured from the programming software.

See on-line help of the programming software for more information on configuration.

Modifying the State of a Coil or a Contact

To modify the type of a coil or a contact from the front panel of the smart relay (the programming window displayed on screen):

- Position the cursor on the symbol representing the coil type or on the letter of the contact,
- Scroll through the possible coil or contact types (V for a normally open contact, v for a normally closed contact).

For more details, refer to Method for Entering a Contact or Coil (*see page 47*).

Initialization

Status of contacts on program initialization:

- Normally open (direct state) is inactive,
- Normally closed (reverse state) is active.

Analog Comparators

Description

The **Analog Comparators** function block is used to:

- Compare a measured analog value with a reference value.
- Compare two measured analog values.
- Compare two measured analog values with hysteresis parameter.

The result of this comparison is used in the form of a contact.

Analog automation functions can be used for smart relays with a real time clock and DC power supply, and with mixed discrete and analog inputs.

The following indicate the existence of mixed discrete and analog inputs:

- The existence of inputs numbered from **IB** to **IG** (maximum configuration). These inputs are used to receive analog signals from 0.0 V to 9.9 V inclusively.
- The presence of the **Analog Comparators** function in the toolbar of the programming software.

These smart relays have 16 **Analog Comparators** function blocks, numbered from 1 to 9 then from A to G.

Use as a Contact

The contact shows the position of a measured analog value in relation to a reference value or to another measured value.

It may be used as many times as necessary in the program either as normally open or as normally closed:

Normally open:

Symbol of the normally open contact associated with an Analog Comparator:

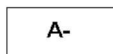

The contact is **conducting** when the comparison condition is **verified**.

Normally closed:

Symbol of the normally closed contact associated with an analog comparator:

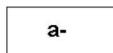

The contact is **conducting** when the condition is **not verified**.

Configuration from Front Panel

The comparison formula is as follows:

$x1 < \text{Comparison Operator} > x2$

The comparison formula, for a comparison with hysteresis is as follows:

$x1 - H \leq x2 \leq x1 + H$

The parameters to enter are the following:

- Values to compare,
- Comparison operator,
- Reference value,
- Hysteresis parameter,
- Parameter lock.

Values to compare:

Symbol of values to compare:

x1 x2

These variables are chosen from among the following:

- Numbered analog inputs from IB to IG (maximum configuration),
- Reference value R

Comparison operator:

The comparison operator is chosen using the number in the upper right-hand side of the front panel display.

The table below provides the correspondence between this number and the comparison formula that will be used:

Number	Comparison formula
1	$x1 > x2$
2	$x1 \geq x2$
3	$x1 = x2$
4	$x1 \neq x2$
5	$x1 \leq x2$
6	$x1 < x2$
7	comparison with hysteresis: $x1 - H \leq x2 \leq x1 + H$

Reference value:

Symbol of the reference value:

R

The reference value is a constant to which a measured value may be compared. It must be between 0 and 9.9.

Hysteresis parameter:

Symbol of the hysteresis parameter:

H

The hysteresis parameter is a constant used to define an interval in which the 2x variable should be found for the comparator to be active. Its value must be between 0 and 9.9.

Parameter locking:

Symbol of the Parameter lock parameter:

 Locked  Unlocked

Locking prevents the modification of locked parameters from the front panel of the smart relay via the PARAMETERS menu.

Illustration:

Configuration from the front panel of the smart relay, of the hysteresis-type comparator with constant reference value:

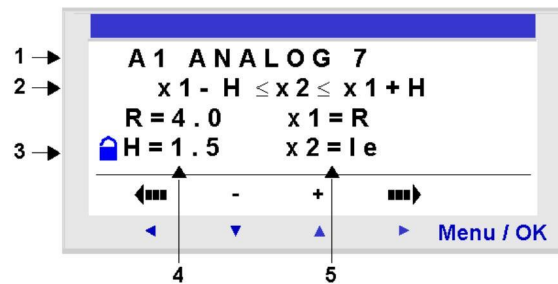

In this case: The comparison condition is verified when the power to the input terminal Ie is between 2.5 V and 5.5 V.

Configuration of a single comparator from the front panel:

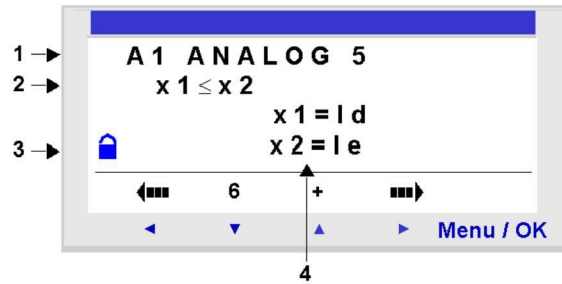

Description:

Number	Parameter	Description
1	Type of comparison	The number that follows ANALOG corresponds to the selected comparison operator.
2	Comparison formula	Formula used for comparison.
3	Parameter lock 	Locking prevents locked parameters from being modified from the front panel of the smart relay using the PARAMETERS menu.
4	Parameters of the comparison formula	Parameters of the comparison formula.

Modifying the State of a Coil or a Contact

To modify a contact from the front panel of the smart relay (the programming window is displayed on the screen):

- Place the cursor over the letter of the contact,
- Scroll through the possible contact types (A for a normally open contact, a for a normally closed contact).

For more details, refer to Method for Entering a Contact or Coil (*see page 47*).

Initialization

Status of the contacts and value on initialization of the program:

- The normally open (direct state) is inactive,
- The normally closed (inverse state) is active.

Example

A heating resistance is to be triggered by the smart relay Q1 output when the temperature is below 20° C.

A temperature probe is used, providing a 0 to 10 volt signal for a -10° to +40° C temperature range. A temperature of 20° C corresponds to a voltage level of 6 volts on the probe.

You would write the following Ladder program:

```
A1-----[Q1
```

Using the following parameters for the A1 comparator:

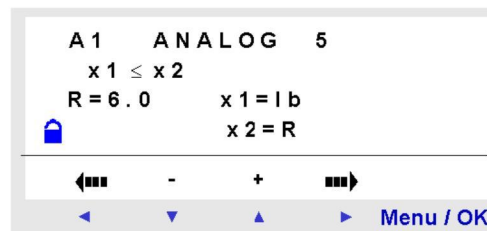

The comparison operator 5 is chosen, that is “inferior or equal to”.

The values to compare are chosen: The analog input IB (to which the temperature probe is connected) for the first, the reference value R for the second.

The reference value is set to 6.

The analog comparator is thus active when the power measured on the analog input IB is less than or equal to 6 V. This is when the probe measures a temperature less than or equal to 20 °C.

Clocks

Description

Use the **Clocks** function to validate the time ranges during which actions can be executed. The smart relay has 8 **Clocks** function blocks numbered from 1...8. Each of these has four programming ranges and behaves like a weekly programmer. The **Clocks** function blocks are used like contacts.

Use as a Contact

This contact may use the direct state of the Clock function block (normally open contact) or its inverse state (normally closed contact), see below.

Normally open:

Symbol of the normally open contact, representing a clock:



The contact is conducting when the clock is in a validity period.

Normally closed:

Symbol of the normally closed contact, representing a clock:



The contact is conducting when the clock is not in a validity period.

Configuration from Front Panel

Configuration screen of a Clock function block from the front panel of the smart relay:

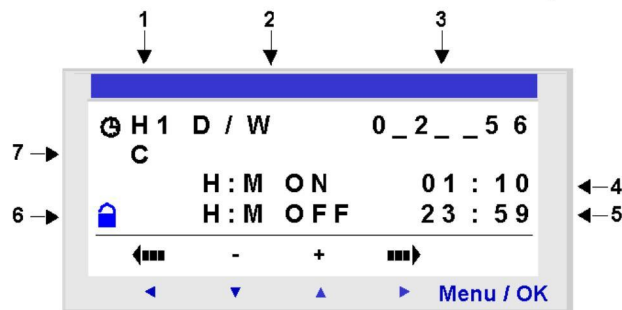

Number	Parameter	Description
1	Clock module number	8 clocks available, numbered 1...8.
2	Type of date configuration	D/W: Days of the Week.
3	Validity day (D/W type)	Validity day: <ul style="list-style-type: none"> ● 0: Monday ● 1: Tuesday ● ... ● 6: Sunday Unselected days are indicated by a _.
4	Start time (D/W type)	This is the start time from 00.00...23:59.
5	Stop time (D/W type)	This is the end time from 00.00...23:59.
6	Parameter lock 	Locking prevents locked parameters from being modified from the front panel of the smart relay using the PARAMETERS menu.
7	Operating ranges	4 operating ranges are available: A, B, C, D. In operation, these ranges are cumulative: The block is valid over the selected ranges.

If the clock is set to ON on Monday at 23:00 and set to OFF on Monday at 1:00, then it does not change to OFF on Tuesday at 1:00 but effectively on the following Monday at 1:00. Moreover, if no other command has been made, the clock remains positioned at ON all other days of the week.

Combining Operating Ranges

Operating ranges can be mixed for the same clock.

Example: Using the four operating ranges with different settings.

Operating range	Program
A: time range	Every day from Monday to Friday, start at 8.00 and end at 18.00.
B: Day/Night	Every day from Tuesday to Thursday: start at 22.00 and end the following day at 6.00.
C: interval	Start on Friday at 20.00.
D: Interval	End on Monday at 03.00.

Modifying the State of a Coil or a Contact

To modify the type of a coil or a contact from the front panel of the smart relay (the programming window displayed on screen):

- Place the cursor over the letter of the contact,
- Scroll through the possible contact types (H for a normally open contact, h for a normally closed contact).

For more details, refer to Method for Entering a Contact or Coil (*see page 47*).

Example

You wish to control a device connected to the Q2 output of the smart relay. You want it to be active on the following two clock ranges:

- from Monday to Saturday, from 09:00 to 13:00.
- from Monday to Friday, from 15:00 to 19:00.

For this, the H1 Clock block is used and the following wiring sheet is created:

H1----- [Q2

When entering the H1, Clock block, configure the operational ranges **A** and **B** as described in the table below:

Screen	Comment
	First Slot A: From Monday to Saturday, from 09:00 to 13:00.
	Second Slot B: From Monday to Friday, from 15:00 to 19:00.

TEXT

Description

The **TEXT** function is used to display text, a date, a time, and numerical values on the LCD display, instead of the inputs-outputs states.

One single **TEXT** function block is used to define the content of the entire LCD display. The content can be a combination of:

- Text (maximum 72 characters),
- Numerical values corresponding to the output of a function used in the application (for example a counter). These values can include a decimal point.
- Date, time or calibration value from the **Clocks** function.

It is possible to authorize the modification of the content using the keys on the front panel.

The smart relays have 16 **TEXT** blocks, numbered from 1...9 then from A to G. These function blocks are used as coils.

The maximum number of variables that can be displayed per **TEXT** block is 4.

Up to 16 **TEXT** blocks may be used (TX1 to TXG) simultaneously in one program, but only the block which is activated is displayed. If multiple blocks are activated, the block with the highest number is displayed.

To switch the display from the **TEXT** screen to the **INPUTS-OUTPUTS** screen, hold down the **Shift** key, then press the **Menu/OK** key.

NOTE: The **TEXT** blocks are only programmable from the programming software.

Used as a Coil

Two coils are associated with each **TEXT** block:

- **Display Activation** coil.
- **Display Deactivation** coil.

The use of these coils is described below.

Display Activation

Symbol of the **Display Activation** coil of a **TEXT** function block:

TX -

This coil displays on the screen the text and/or the values of the associated **TEXT** block when the elements that are connected are conducting.

Display Deactivation

Symbol of the **Display Deactivation** coil of a **TEXT** function block:

RX -

This coil deactivates the display of the text and/or the values of the associated **TEXT** block when the elements that are connected are conducting. The display returns to the inputs-outputs screen.

Example:

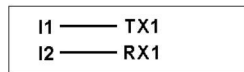

Activation of input **I1** displays the text on the LCD. Activating input **I2** makes the text disappear.

Parameter

The **TEXT** function blocks are only programmable from the programming software, see the on-line help for the programming software for more information.

LCD Screen Backlighting

Description

The **LCD screen backlighting** output is used to control the backlighting of the LCD by a program. In STOP and RUN modes, the LCD screen is illuminated for 30 seconds when a key is pressed on the front panel.

Used as a Coil

Used as a coil, it illuminates the LCD when the elements to which it is connected are conducting. Symbol of the coil of the LCD screen Backlighting function:

TL1

The screen is illuminated if this coil is active.

Change to Summer / Winter Time

Description

The output of this function is in an OFF state over the entire duration of winter time, and switches to ON for the entire duration of summer time.

By default, there is no change in winter / summer time. This function must be activated, either from the programming software, or from the front panel of the smart relay.

To activate this function from the front panel of the smart relay, proceed as described in chapter CHANGE SUM/WIN Menu (*see page 85*).

NOTE: This function is only available for smart modules that contain a real-time clock.

Use as a Contact

When used as a contact, this element indicates winter time or summer time.

It may be used as many times as necessary in the program either as normally open or as normally closed:

Normally open:

Symbol of the normally open contact associated with a Change summer / winter time function block:

W 1

The contact is active for the entire duration of summer time.

Normally closed:

Symbol of the normally closed contact associated with a Change summer/winter time function block

w 1

The contact is active for the entire duration of winter time.

Parameters

The following settings are possible:

- **No:** no change,
- **Automatic change:** Dates are preset according to geographic zone:
 - **EUROPE:** Europe,
 - **USA.**
- **OTHER ZONE:** The change is automatic, but you must specify the month: **M** and the Sunday: **S** (1, 2, 3, 4 or 5) on which the summer/winter change takes place.

Modifying the State of a Coil or a Contact

To modify a contact from the front panel of the smart relay (the programming window displayed on screen):

- Place the cursor over the letter of the contact,
- Scroll through the possible contact types (**W** for a normally open contact, **w** for a normally closed contact).

For more details, refer to Method for Entering a Contact or Coil (*see page 47*).

Initialization

State of the contacts and value on initialization of the program:

- The **normally open** (direct state) is **inactive**,
- The **normally closed** (inverse state) is **active**.

Modbus Inputs/Outputs

Description

A Modbus **SR3MBU01BD** extension module may be added onto an extensible smart relay. In LD mode, the application cannot access the four 16-bit data exchange words. Data transfer between master and slave is implicit and transparent.

NOTE: The Modbus module only operates as Modbus slave.

Parameters

The Modbus module can be configured only from the programming software (see the on-line help of the programming software for more information).

Words to be sent to master

Writing these words to the master is automatically performed by duplication of the status of the discrete I/Os as follows:

																Modbus Address (Hexa) ↓		
IG	IF	IE	ID	IC	IB	IA	I9	I8	I7	I6	I5	I4	I3	I2	I1	0x0014		
0	0	0	0	0	0	0	0	0	IR	IQ	IP	IN	IL	IK	IJ	IH	0x0015	
0	0	0	0	0	0	0	QA	Q9	Q8	Q7	Q6	Q5	Q4	Q3	Q2	Q1	0x0016	
0	0	0	0	0	0	0	0	0	0	0	0	QG	QF	QE	QD	QC	QB	0x0017
Most significant byte								Least significant byte										

I1 to IG: discrete input states for the SR3B261BD base.

IH to IR: discrete input states for the SR3XT141BD extension.

Q1 to QA: discrete output states for the SR3B261BD base.

QB to QG: discrete output states for the SR3XT141BD extension.

Words sent by the master

The words sent by the master are not implicitly operated on by the smart relay.

These 4 16-bit words have the following addresses (Hexa): 0x0010 / 0x0011 / 0x0012 / 0x0013.

Message

Description

When activated, the **Message** function block can be used to:

- Send alarm messages to mobile phones, the Zelio Logic Alarm tool or Email addresses via the SR2COM01 communication interface
- Provide remote access to I/O and/or a digital variable for reading or modifying them.

There are 28 **Message** function blocks numbered from S1...S9, then from SA...SV (SI, SM, SO are not used).

NOTE: The **Message** function is only available on smart relays with clocks and when an SR2COM01 communication interface is added.

For further information on the configuration of the SR2COM01 communication interface, see the programming software on-line help.

Use of the Coil

Command input

Symbol of the Command Input coil of a **Message** function block:



This coil sends the configured alarm message in the associated **Message** function block, when it is activated.

Depending on the configuration of the **Message** function block, the coil may be activated during detection on its input, by a transition:

- From Inactive to Active State (by default),
- From Active to Inactive State.

See on-line help for the programming software for more information on configuring the **Message** function block.

Use as a Contact

The contact associated with the **Message** function block indicates whether the function block is activated.

It may be used as many times as necessary in the program either as normally open or as normally closed:

Normally open:

Symbol of the normally open contact associated with a **Message** function block:



The contact is conducting when the function block is activated.

Normally closed:

Symbol of the normally closed contact associated with a **Message** function block:



The contact is conducting as long as the function block is not activated.

Example: Illuminating an LED connected to the **Message** No.1 function block output

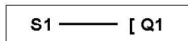

When function block no. 1 is activated, the associated alarm message is sent and the LED is illuminated, otherwise it is off.

Modifying the State of a Coil or a Contact

To modify the type of a coil or a contact from the front panel of the smart relay (the programming window displayed on screen):

- Position the cursor on the symbol representing the coil type or on the letter of the contact,
- Scroll through the possible contact types (S for a normally open contact, s for a normally closed contact).

For more details, refer to Method for Entering a Contact or Coil (*see page 47*).

Configuration from the Front Panel

The **Message** function block cannot be configured from the front panel of the smart relay. This function must be configured from the programming software.

See on-line help of the programming software for more information on configuration.

Initialization

Status of contacts on program initialization:

- The normally open (direct state) is inactive,
- The normally closed (inverse state) is active.

Part IV

Creating and Debugging an Application

Subject of this Section

This section describes, using detailed examples, how to create, debug and save an application.

What Is in This Part?

This part contains the following chapters:

Chapter	Chapter Name	Page
17	Implementing an Application	145
18	Debugging an Application	159
19	Transfer of Ladder Diagrams	167
20	Sample Application	169

Chapter 17

Implementing an Application

Subject of this Chapter

This chapter describes the implementation of an application from the front panel of the smart relay.

What Is in This Chapter?

This chapter contains the following topics:

Topic	Page
Presentation of Ladder Diagrams	146
Using the Reverse Function	148
Notation Used by the Smart Relay	150
Application: Implementing a Two-way Switch	152

Presentation of Ladder Diagrams

Description

In this section, we will use an example to understand how a ladder diagram works for a two-way switch.

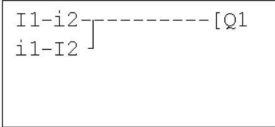
Electrical diagram	Ladder diagram
	
<p>The two position switches VV1 and VV2 control turning lamp L1 on and off.</p>	<p>I1 and I2 are two contacts representing inputs 1 and 2 on the smart relay. Q1 is a coil that corresponds to output 1 from the smart relay.</p>

Module Wiring

Below, an illustration of smart relay wiring:

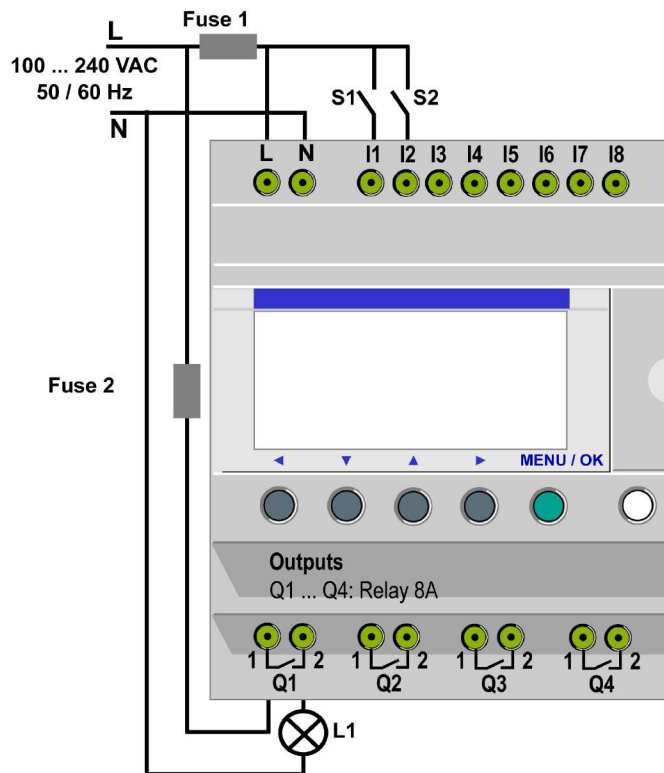

Application Operation

Using a smart relay means that ordinary switches (with open or closed positions) can be used in place of two position switches.

The switches are identified as **S1** and **S2** in the wiring diagram above.

S1 and **S2** are connected to inputs **I1** and **I2** on the smart relay.

The operating principle is as follows: Each time the status of inputs **I1** and **I2** changes, the status of output **Q1** also changes which controls the lamp **L1**.

The ladder diagram uses simple functions, for example placing contacts in parallel and in series, as well as the reverse function identified as **i1** and **i2** (see *Using the Reverse Function*, [page 148](#)).

NOTE: The implementation of a two-way switch is optimum when impulse relay coils are used (see *Discrete Outputs*, [page 98](#)).

Using the Reverse Function

Description

The reverse function, noted *i* in the smart relay is used to obtain the reverse state of input *I* wired on the smart relay.

Practical Example

Below is the electrical diagram of the example and an illustration of the smart relay wiring:

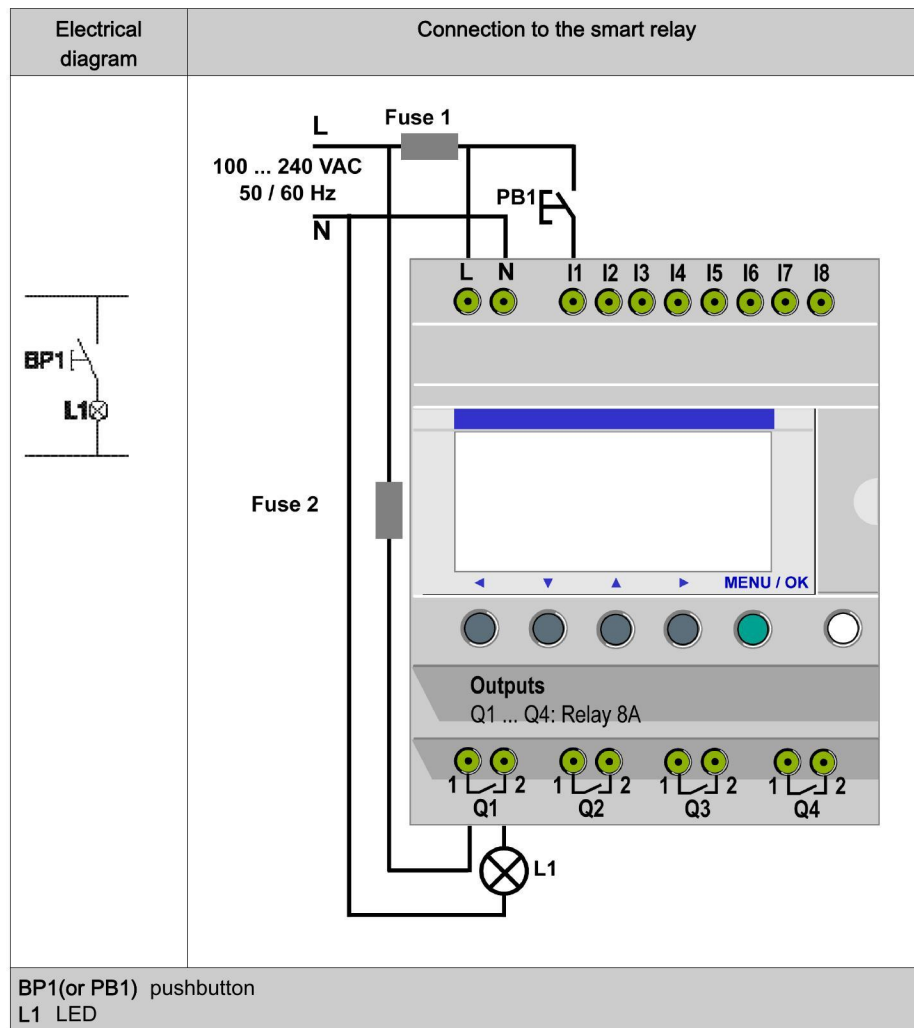

Depending on the ladder diagram, two solutions are possible:

Ladder diagram 1: Light off when idle	Ladder diagram 2: Light on when idle
I1-----[Q1]	i1-----[Q1]
I1 corresponds to the image of BP1, pressing BP1 activates input I1, so that the Q1 output is activated and the lamp L1 is illuminated.	i1 corresponds to the reverse image of BP1, pressing BP1 activates input I1 and therefore contact i1 is disabled, output Q1 is disabled and the lamp L1 is not illuminated.

General Case

The table below illustrates the operation of a pushbutton connected to the smart relay. Pushbutton BP1 is connected to input I1 and lamp L1 is connected to output Q1 on the smart relay.

	Off delay		Operating	
	Electrical diagram	Smart relay symbols	Electrical diagram	Smart relay symbols
Pushbutton normally open		I1 = 0 i1 = 1		I1 = 1 i1 = 0
Pushbutton normally closed		I1 = 1 i1 = 0		I1 = 0 i1 = 1

NOTE: The reverse function may be applied to the contacts in a ladder diagram, whether they represent outputs, auxiliary relays or function blocks.

Notation Used by the Smart Relay

Description







The smart relay has a 4-line display used to show ladder diagrams.

NOTE: The programming software allows you represent ladder diagrams in three different formats:

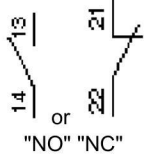
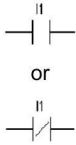
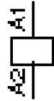
- Electrical symbols
- Ladder symbols
- Smart relay symbols

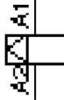
Equivalences Between Notations

In the table below are the representations of common elements in the 3 formats:

Electrical symbol	Ladder symbol	Smart relay symbols
 <p>"NO" "NC"</p>	 <p>or</p>	<p>I1 or i1</p> <p>I1 or i1</p>
		<p>[Q1</p>
 <p>Set coil (SET)</p>		<p>SQ1</p>
 <p>Reset coil (RESET)</p>		<p>RQ1</p>

Other Elements

Other elements are also available using a smart relay, such as:

- **Timer function block:** Used to delay, prolong and control and action for a set length of time,
- **Counter function block:** Used to count the pulses received on an input,
- **Clock function block:** Used to trigger or release actions on precise days or at precise times,
- **Analog comparator function block:** Used to compare an analog value with a reference value or with another analog value after allowing for a hysteresis factor,
- **Auxiliary relays:** These are used to save or relay the status of the smart relay,
- **Zx keys:** After confirming this function, Z keys may be used as pushbuttons,
- **Fast counter function block:** The fast counter function is used to count pulses up to a frequency of 1 kHz.
- **LCD screen back-light function block:** This is used to control the backlighting of the LCD by a program,
- **Summer/winter time change function block:** The output of this function is in an OFF state over the entire duration of winter time, and switches to ON for the entire duration of summer time,
- **Counter Comparator block:** This function is used to compare the values of two counters,
- **Text block:** This is used to display text or numerical values (value or preset value).

NOTE: Blocks **Counter Comparator** and **Text** are not programmable from the front panel.

NOTE: For the list of the ladder diagram elements available when using smart relays, as well as details on their functions and parameters, see the chapter entitled *LD Language Elements*, [page 89](#).

Application: Implementing a Two-way Switch

Description

In the text that follows you will find detailed information on the procedure for entering a ladder diagram for a two-way switch.

You should proceed as follows:

- Go to the programming screen,
- Enter the contacts in the first line,
- Enter the coil in the first line and link it to the contacts,
- Enter the contacts in the second line,
- Link the second line to the first,
- Launch the program.





To read the next procedures, from the main smart relay screen (the one shown on power-up), follow the instructions written in the **Action** column and press the specified key.

The **Screen** column shows what you see on the smart relay screen.

The **Comments** column provides some additional information on entry and display actions.

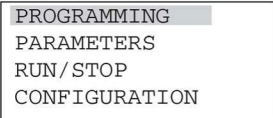



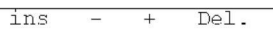

Go to the Programming Screen

To access the screen from which we will program the two-way switch, proceed as follows:

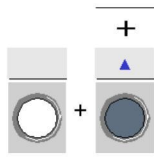
Step	Action	Smart relay screen	Comment
1			Position the cursor on PROGRAMMING; it will flash when selected.
2			After briefly displaying: LINE 1 (for approx. two seconds), a ■ flashing cursor is displayed.
3			Pressing and holding down the Shift key (white) will make a contextual menu appear that is used for programming the contacts and the coils.

Entering the Contacts in the First Line

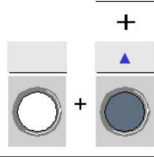
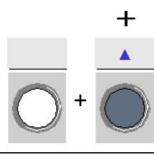
To enter the contacts in the first line, proceed as follows:

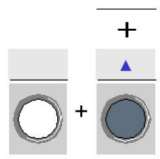

Step	Action	Smart Relay Screen	Comment
1		I1	The I flashing cursor is positioned on the I. The smart relay prompts you to select the type of contact.
2		I1	The 1 flashes. You have selected a contact assigned to an input (I), the smart relay now prompts you to select the input number.
3		I1	The 1 flashes, indicating a link point for linking connections.
4		I1	The I flashes. You just confirmed entry of the contact associated with the input I1. The I is positioned for entering the second contact.
5		I1-I1	The right side I will begin flashing. The smart relay prompts you to select the type of contact.
6		I1-i1	The i flashes. You have just selected the reverse contact assigned to an input.
7		I1-i1	The 1 on the right flashes. Now enter the input number.

Step	Action	Smart Relay Screen	Comment
8		I1-i2	The 2 flashes.

Entering the Coil and Linking it to the Contacts

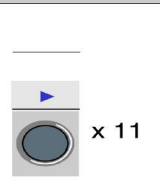
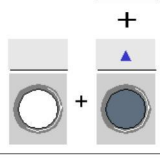
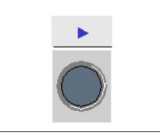
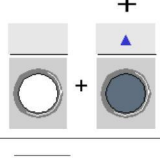
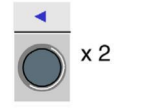



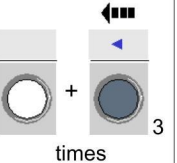
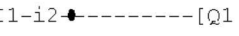



To enter the coil in the first line and connect it to the coils, proceed as follows:

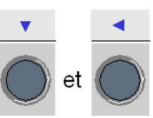

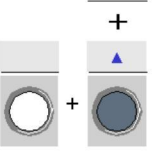
Step	Action	Smart Relay Screen	Comment
1		I1-i2 ● I1-i2 ■ ... then I1-i2 ■	The cursor flashes in succession: ● At a link point: ●, ● At a contact point: ■. Until positioned at the end of the line ready to enter the coil.
2		I1-i2 [M1	The [flashes.
3		I1-i2 [M1	The M flashes.
4		I1-i2 [Q1	The Q flashes.
5		I1-i2 [●Q1	The cursor ● is displayed.

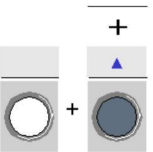
Step	Action	Smart Relay Screen	Comment
6			Pressing and holding down the Shift key (white) will make a contextual menu appear that is used for programming the connections.
7			The link is created.

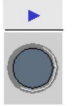
Entering the Contacts in the Second Line

To enter the contacts in the second line, proceed as follows:

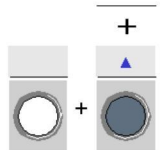
Step	Action	Smart Relay Screen	Comment
1	 as many times as necessary until positioned at the start of the line.		The ■ is at the start of the following line.
2			The I located on the second line flashes.
3			The i located on the second line flashes.
4			The 1 located on the second line flashes.

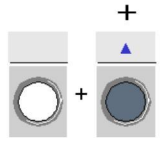
Step	Action	Smart Relay Screen	Comment
5		I1-i2-----[Q1 i1 ■	The ■ flashes.
6		I1-i2-----[Q1 i1-I1	The I located on the second line flashes.
7		I1-i2-----[Q1 i1-I1	The second 1 in the second line flashes.
8		I1-i2-----[Q1 i1-I2	The 2 located on the second line flashes.





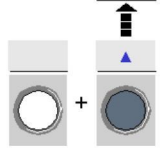

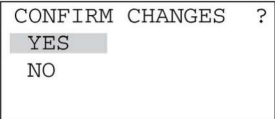

Linking the Second Line to the First

To link the second line to the first, proceed as follows:

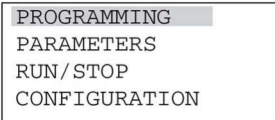
Step	Action	Smart Relay Screen	Comment
1		I1-i2-----[Q1 i1-I2 ●	The ● flashes. This shows that it is possible to connect a link at this point.
2		I1-i2-----[Q1 i1-I2]	The ● has changed into a which creates the link between the two lines.

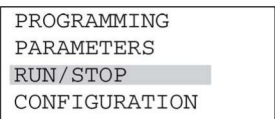
Launching the Program

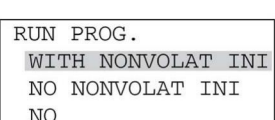
To launch the program, proceed as follows:

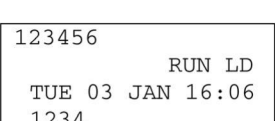
Step	Action	Smart Relay Screen	Comment
1			Now confirm the changes. YES flashes.
2			The main menu re-appears. PROGRAMMING is selected (flashes).
3	 x 2		RUN/STOP is selected (flashes).
4			Now start the program using the required option (<i>see page 59</i>).
5			The main menu re-appears.

The Main Points

This application example illustrates how to enter a ladder diagram.

- When a **■** or a **●** is flashing, use the **Shift** key to add an element (contact, coil or graphic link element),
- When an element is flashing (I, Q, No., **■** etc.), it is possible to use the **Shift + Z2** and **Z3** arrows on the arrow keypad to select the required element,
- It is also possible to use the **Z1** to **Z4** arrows on the arrow keypad to move around the ladder diagram.

Chapter 18

Debugging an Application

Subject of this Chapter

This chapter presents the tools available for debugging an application loaded in the memory of the smart relay.

What Is in This Chapter?

This chapter contains the following topics:

Topic	Page
Introduction	160
Run Mode Ladder Diagrams	162
Run Mode Function Block Parameters	163
Run Mode Menus	164
Smart Relay Reaction to a Power Outage	165

Introduction

Smart Relay Module in RUN Mode

Once an application has been entered in ladder diagram form, debugging tests must be run.

The first step is to set the smart relay to RUN. To do this, in the RUN/STOP option in main menu and select RUN.

From this moment on, the smart relay handles the physical inputs and outputs according to the instructions entered in the ladder diagram.

Viewing Status:

In RUN mode, the states of inputs and outputs are displayed on the main screen:

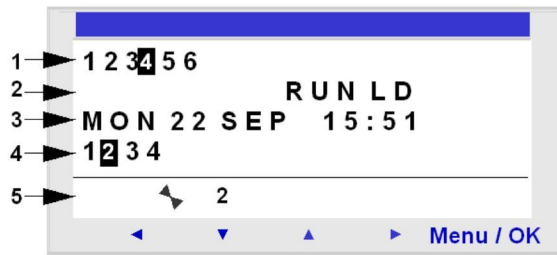

Prompt	Element
1	Display input status
2	Display run mode (RUN/STOP) and mode in use.
3	Displays date and time for products with clocks.
4	Output status display.
5	Contextual menus / pushbuttons / icons indicating operating modes.

When inputs or outputs are activated, they appear in reverse video (using white on a black background).

Contextual Menu

Below is an illustration of the icons in the contextual menu when the smart relay is in RUN mode:

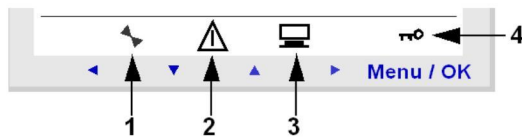

Prompt	Element
1	Status of the smart relay: In RUN it is in motion, in STOP it is immobile.
2	Indicates that errors have been detected (see <i>DEFAULT Menu</i> , page 79).
3	Indicates that the smart relay is connected to the programming software.
4	The key indicates that the program is password-protected.

Run Mode Ladder Diagrams

Viewing Ladder Diagrams

NOTE: Viewing I/O and variable values can be accessed only in LD/ RUN mode.

The smart relay can dynamically display the performance of a ladder diagram. To do this, simply call up the **MONITORING** menu and position the cursor over the lines to display using the navigation keys.

Each conducting contact or energized coil is displayed in reverse video (white on black):

```
I 1-i 2-I4-----[M1
IB-----I 5i3-[M2
M1-M2-----[Q1
H2-----[Q2
```

Modifying Ladder Diagrams

You cannot modify the ladder diagram lines in RUN mode.

However, you can modify some of the function block parameters in the **MONITORING** menu.

Using Z Keys as Pushbuttons

On the INPUTS-OUTPUTS screen in RUN mode, the numbers of the Z keys used in the program are displayed in the contextual menu. Press and hold down the **Shift** key to display the contextual menu.

To enable a Z key, press on the key located under the number.

Illustration:



NOTE: The Zx keys function is disabled in the **PARAMETERS** and **MONITORING** menus and in the function block parameter screens and configuration screens.

Run Mode Function Block Parameters

Presentation

In RUN mode a function block preset value may be changed dynamically if it is not locked.

Functions with parameters in LD mode:

- Auxiliary relays (latching),
- Discrete Outputs (latching),
- Clocks
- Analog comparators,
- Timers
- Counters
- Fast counters.

Functions with parameters in FBD mode:

- Numerical constant-type inputs,
- Clock,
- Gain,
- Timers: TIMER A/C, TIMER B/H, TIMER Li,
- Counter: PRESET COUNT / UP DOWN COUNT,
- H-SPEED COUNT fast counter,
- PRESET H-METER hour counter,
- CAM block,
- PID.

Accessing / Modifying parameters

Parameters may be accessed from the following screens:

- **PARAMETERS:** See *PARAMETERS Menu, page 55*,
- **MONITORING:** on the ladder diagram.

To modify the parameters of an element from the MONITORING menu, proceed as follows:

Step	Action
1	Position the cursor on the element to modify using the navigation keys.
2	At the same time, hold down Shift and the Param key to open the parameter window.
3	Position the cursor on the modifiable parameter fields using the navigation keys: ◀ ▶.
4	Modify the value of the parameter using the ▲ and ▼ (+ and -) keys, holding down Shift .
5	Confirm the modifications by pressing Menu/OK , which will open the confirmation window. Confirm a second time by pressing Menu/OK to save.

NOTE: Only the parameters of unlocked blocks may be modified.

Run Mode Menus

Run Mode Menus

Some menus are accessible when the smart relay is in RUN mode, while others are not. Here is a summary table.

Menu	LD	FBD
PROGRAMMING		
MONITORING	✓	
PARAMETERS	✓	✓
RUN / STOP	✓	✓
CHANGE D/T	✓	✓
CHANGE SUMM/WINT	✓	✓
CONFIGURATION		
PASSWORD		
FILTER		
Zx KEYS		
WATCHDOG CYCLE		
CLEAR PROG.		
TRANSFER		
VERSION	✓	✓
LANGUAGE	✓	✓
DEFAULT	✓	✓

Smart Relay Reaction to a Power Outage

Description

A power outage may cause the smart relay to restart and lose any data not declared as non-volatile.

Smart relays have the ability to maintain the time for at least 10 years.

In addition, it is also possible to back up the variables configured with the **Latching** option defined in the parameters window.

Latching

The **Latching** function is used to save the counter values in the event of a power outage.

The blocks that have this function are the following:

- In LD mode:
 - Auxiliary relays,
 - Discrete outputs,
 - Timers
 - Counters
 - Fast counter,
- In FBD mode:
 - AC, BH, Li timer,
 - Cam programmer function CAM BLOCK,
 - PRESET COUNT, UP DOWN COUNT counter,
 - PRESET H-METER hour counter,
 - Data archiving function ARCHIVE,
 - Fast counters.

Locked Coil Control

If the result of losing the time setting is to lock coil control, then simply use a clock contact without a stop order in series with the action coils.

Example of a **non-locked** coil:

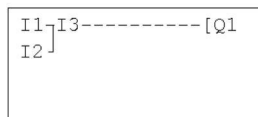

The contact line for coil Q1 will be active even if the time and date setting is lost.

Example of a locked coil:

```
I 4-H1-----[Q2
```

With the clock function block 1 configured as follows:

```
⊙H1 D/W    0123456  
A  
  H:M ON   07:00  
  H:M ON   --:--
```

The contact line for coil Q2 will only be active after setting the clock.

Chapter 19

Transfer of Ladder Diagrams

Transferring Ladder Diagrams

Description

It is possible to transfer a ladder diagram from the smart relay toward a backup memory (optional) and vice-versa.

This allows:

- To backup an application, then restore it, if necessary,
- To make a copy of an application for loading it in other smart relays.

Transferring an Application

Transferring an application from a smart relay to the backup memory, or from the backup memory to the smart relay, is performed using the menu: **TRANSFER**.

The procedure is described in detail in the chapter **TRANSFER Menu**, see *TRANSFER Menu*, [page 71](#).

Chapter 20

Sample Application

Subject of this Chapter

In this chapter we'll use the example of an underground car park control. From given specifications, we will develop the application to program in the smart relay.

What Is in This Chapter?

This chapter contains the following topics:

Topic	Page
Specifications	170
Specification Analysis	171
Implementing the Solution	173

Specifications

Objective

We wish to centralize the control of the underground car park of an administrative building.

Automatic Gate

The entrance and the exit of the car park are controlled by an ordinary automatic gate.

The gate has the usual features such as:

- Gate timing (opening and closing) by passing vehicles,
- External control for locking in closed position, etc.

Counting Vehicles

In addition, we would like to keep track of vehicles parked in the facility.

We would be able to control a lighted panel that informs drivers when all parking spaces are occupied and prevents access by locking the gate in the closed position.

It must also be possible to override this function when necessary to allow access for emergency services (fire department, emergency medical service, etc.).

Open Time

We would also like to prevent access to the facility when the building is closed.

Authorized personnel should be allowed to prevent the gate from locking in extraordinary circumstances. The hours of opening are the following: Monday to Friday from 8:30 am to 5:30 pm, Saturday from 9:30 am to 12:00 pm and closed on Sundays.

Removal of Gasses

It is also necessary to remove carbon dioxide by using a fan when the measured concentration levels exceed permissible levels.

A specialized sensor will be used that provides an output value between 0 and 10V.

Lighting

There is also a requirement to control lighting, triggered by a vehicle arriving and via pushbutton switches placed near the pedestrian access points.

To save energy, lights will turn off after 10 minutes.

Manual Counting

In addition, we need to manually provide information on the number of vehicles parked in the facility. We need to be able to manually increase or decrease the number of vehicles counted by the smart relay.

Specification Analysis

Description

Analysis of the specifications includes listing inputs, keys, outputs and function blocks necessary to prepare the application.

Inputs

Below is the list of inputs that the application will use:

Inputs	Description
Input I1	Vehicle entry detection.
Input I2	Vehicle exit detection.
Inputs I3 and I4	Pushbuttons at pedestrian access points. They are used to illuminate the facility. One for the elevator and one for the stairway (no pedestrian access is allowed via the vehicle entrance).
Analog input IB	CO ₂ level sensor.

Function keys

Below is the list of keys that the application will use:

Function keys	Description
Function key Z1	Manually increments the number of vehicles in the car park.
Function key Z2	Resumes automatic entry control.
Function key Z3	Manually decrements the number of vehicles in the car park.
Function key Z4	Manually releases the entrance barrier.

Outputs

Below is the list of outputs that the application will use:

Outputs	Description
Output Q1	Indicates when the car park facility is full.
Output Q2	Locks the entry barrier (inhibits entry barrier opening) when the car park is full or outside of opening hours.
Output Q3	Lighting.
Output Q4	Controls the polluted air extraction fan control.

Special function blocks

Below is the list of special function blocks that the application will use:

Special function blocks	Description
Counter C1	Counts the number of vehicles in the car park (93 maximum).
Clock function block H1	Manages car park access hours.
Timer function block T1	Lighting timer (10 minutes).
Analog function block A1	Compares the CO2 level measured with the maximum threshold. The maximum threshold value corresponds to 8.5 Volts.
Timer function block T2	Fan timer (15 minutes).

Hardware Solution

To implement this solution, we use a smart relay with analog inputs, clock function blocks and at least 4 discrete inputs and outputs.

Implementing the Solution

Description

Presented here are the control diagrams to program, as well as the parameters to use for the function blocks.

Implementing the Ladder Diagram

Below is the control diagram to program:

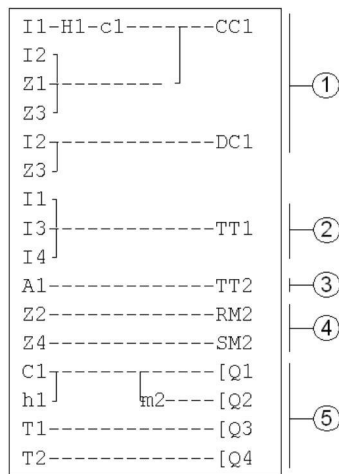

Prompt	Element
1	Counting vehicles in, subtracting vehicles out and manually updating the number of vehicles actually in the car park.
2	Starting the lighting timer.
3	Starting the fan timer.
4	Handling the manual release function.
5	Outputs command: Car park full indicator, blocking the input, lighting the car park and running the extraction fan.

When upcounting and downcounting, the counter locks up when the car park becomes full (no spurious detection or counting actions take place if vehicles are allowed to enter by manual release).

NOTE: For a given counter, the coils CC and DC should only appear once in a ladder diagram.

In addition, output Q2 is activated when entry into the car park is not allowed. This leads to the use of an auxiliary relay to manually lock or unlock the access gate using the navigation keys.

Configuring the Function Blocks

The table below provides details on the parameters to use for each of the function blocks:

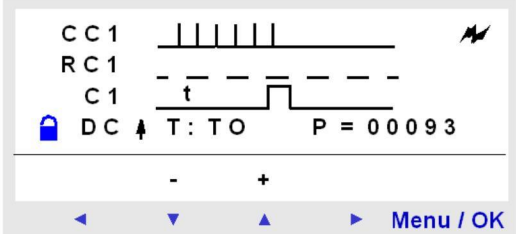
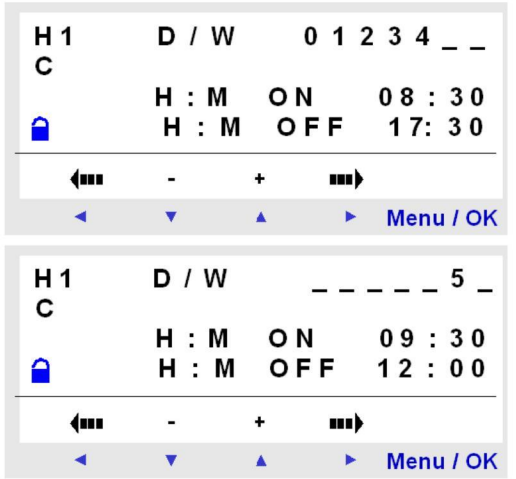
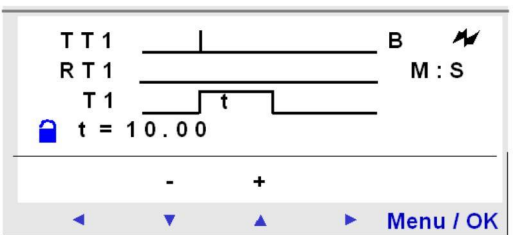
Function block	Comment
<p>Counter function block C1</p> 	<p>The preset value is 93 (the maximum number of vehicles allowed in this car park). Where necessary, this value may be changed during operation.</p>
<p>Clock function block H1</p> 	<p>Open hours:</p> <ul style="list-style-type: none"> Monday to Friday from 8:30 am to 5:30 pm. Saturdays from 9:30 am to 12:00 noon. Closed all day Sundays. <p>Two ranges are used.</p>
<p>Timer function block T1</p> 	<p>Car park lighting timer: 10 minutes.</p>

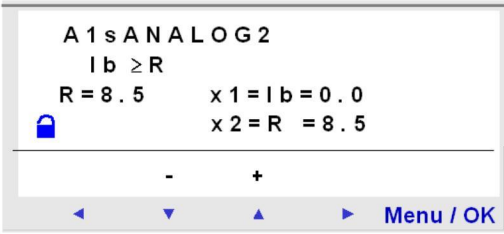
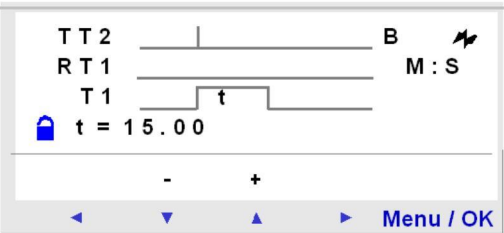
Function block	Comment
<p>Analog function block A1</p> 	<p>Compares the measured CO₂ level with the threshold value: 8.5 V.</p>
<p>Timer function block T2</p> 	<p>Fan operating duration if the CO₂ threshold is exceeded. 15 minutes.</p>

Sample Application

Part V

Diagnostics

Chapter 21

Diagnostics

Subject of this Chapter

This chapter will help you find solutions to operating problems.

What Is in This Chapter?

This chapter contains the following topics:

Topic	Page
Smart Relay Messages	180
Frequently Asked Questions	181

Smart Relay Messages

Description

Here is detailed information on the error messages that are returned by the smart relay, their possible causes and how to remedy the problem.

Error Messages

The table below lists the error messages that a smart relay could return. These messages generally indicate incompatible actions.

Message	Cause	Corrective action
NO PARAMETER	No parameter is available (the diagram does not include elements with parameters).	
TRANSF.ERR.	A transfer was in progress and the link with the PC was interrupted.	Refer to the documentation for the programming software.
TRANSFER ERROR: NO MEMORY	A transfer to the non-volatile memory was requested and the non-volatile memory is not present or incorrectly inserted.	Verify the presence and correct location of the non-volatile memory.
TRANSFER ERROR: CONFIG INCOMPAT	The program to transfer does not match the characteristics of the target smart relay, for example: Clock, analog input, software version.	Verify the origin of the program to transfer and choose a program that is compatible with the appropriate smart relay.
TRANSFER ERROR: VERSION. INCOMPAT	This error is detected if one of the versions of the smart relay does not correspond to the firmware, LD or FBD functions.	Verify the firmware version.
Outputs are displayed flashing on the main screen	One or more static outputs have short-circuited or overloaded.	Remove the cause of the error, then stop the smart relay before selecting RUN mode again.

Frequently Asked Questions

Frequently Asked Questions

Here below are the most frequently asked questions and their answers:

Question	Answer
I cannot access some parameters.	Refer to the documentation to find out whether these elements can be changed. Example of an element that cannot be changed: Counter function block counting direction. This element is only accessible by wiring in a ladder diagram line.
I still cannot access some parameters.	To access the parameters, you must use the navigation keys ◀ and ▶ to position the cursor above them. The ▼ and ▲ are used to change these values. Then press Menu/OK to confirm the changes.
I cannot RUN my smart relay even though I enable the RUN/STOP option in the main menu using the Menu/OK key.	Verify whether the error symbol is displayed in the contextual menu line. Remove the cause of the error in order to RUN the smart module.
I would like to change my diagram lines but the Menu/OK key no longer works.	Ensure that the smart relay is stopped. Modifications in RUN mode are not allowed.
When I try to change my diagram lines, the smart relay shows me a screen with only line numbers (LINE No.). Have I lost my work?	Not necessarily, this situation may occur when 4 consecutive blank lines have been inserted at the start of the ladder diagram or between the command lines.
I have a ladder diagram that uses the Z key (◀, ▼, ▲, ▶) for a pushbutton. I would like to test it but when I display the diagram dynamically, my Z key is no longer operational. Can I make it work?	No this is impossible.
I generated a ladder diagram on a smart relay with a clock. Can I use a backup memory to transfer it to a smart relay without clock?	No this is impossible.
When entering a ladder diagram, the clock function blocks do not appear when choosing the contacts. Is this normal?	Verify whether the smart relay has a clock as the clock function block is only accessible for those references.

Diagnostics

Question	Answer
When entering a ladder diagram, the analog function blocks do not appear when choosing the contacts. Is this normal?	Verify whether the smart relay has analog inputs as the analog function block is only accessible for those references.
I cannot use more than 120 ladder lines or I cannot use more than 16 Timers, counters, auxiliary relays.	The firmware of your module is not up-to-date. It is not necessary to exchange your smart relay. You can update the firmware using Zelio soft (<i>see Zelio Logic Programming Guide,).</i>

Appendices



Appendix A

Compatibility

Subject of this Chapter

This appendix provides information on the compatibility between the versions of the firmware, the versions of the programming software, the available functions and the different memory cartridges.

What Is in This Chapter?

This chapter contains the following topics:

Topic	Page
Zelio Soft 2 Software Version Versus Functions	186
Compatibility between the memory cartridges and the version of the firmware on the smart relay	187

Zelio Soft 2 Software Version Versus Functions

The following table shows the functions available depending on the Zelio Soft 2 software version.

Functions	Zelio Soft 2 software version				
	V2.xx	V3.xx	V4.xx	V5.0	V5.1
LD language					
Maximum number of program lines	–	–	120	240 ⁽¹⁾	240 ⁽¹⁾
Number of auxiliary relays	–	–	28	56 ⁽²⁾	56 ⁽²⁾
Number of counters	–	–	16	28 ⁽³⁾	28 ⁽³⁾
Number of clocks	–	–	8	8	8
Number of timers	–	–	16	28 ⁽⁴⁾	28 ⁽⁴⁾
Number of text blocks	–	–	16	16	16
Number of messages	–	–	28	28	28
FBD language					
Maximum number of function blocks	–	–	255	500	500
Logic functions	Yes	Yes	Yes	Yes	Yes
Standard functions except Sunrise/Sunset and Suntrack	Yes	Yes	Yes	Yes	Yes
Sunrise/Sunset	–	–	Yes	Yes	Yes
Suntrack	–	–	Yes	Yes	Yes
SFC functions	–	–	Yes	Yes	Yes
Application functions (PID)	–	–	–	–	Yes
⁽¹⁾ Only if there is no SR2COM01 module in the configuration. Otherwise, the maximum number of lines is 120. ⁽²⁾ Only if there is no SR2COM01 module in the configuration. Otherwise, the maximum number of auxiliary relays is 28. ⁽³⁾ Only if there is no SR2COM01 module in the configuration. Otherwise, the maximum number of counters is 16. ⁽⁴⁾ Only if there is no SR2COM01 module in the configuration. Otherwise, the maximum number of timers is 16.					

For more information on how to check the firmware version, refer to the **VERSION** Menu (*see page 75*).

Compatibility between the memory cartridges and the version of the firmware on the smart relay

Introduction

The section below describes the compatibility between the memory cartridges and the versions of the firmware on the smart relay.

Compatibility of the Memory Cartridge with the Version of the firmware

The table below describes the compatibility of the memory cartridges with the version of the firmware:

Type of memory cartridge	Version of firmware compatible
SR2MEM01	LD Language: V2.19 or lower. FBD Language: V2.18 or lower.
SR2MEM02	V3.09 or higher.

Transferring a Program from the SR2MEM01 Memory Cartridge to the Smart Relay

In the case of a transfer of the program from the SR2MEM01 memory cartridge to the smart relay, compatibility is as follows:

		Smart relay firmware language	
		LD	FBD
Memory cartridge program language	LD	Compatible if the versions of the memory cartridge and smart relay match.	The LD firmware version must be transferred to the smart relay.
	FBD	The LD firmware version must be transferred to the smart relay.	Compatible if the versions of the memory cartridge and smart relay match.

Transferring a Program from the SR2MEM02 Memory Cartridge to the Smart Relay

In the case of a transfer of the program from the SR2MEM02 memory cartridge to the smart relay, compatibility depends upon the firmware version of the smart relay that the program was loaded from, and the hardware version of the smart relay that the program is being transferred to:

- If the memory cartridge was loaded from a smart relay using firmware version 4.04 or lower, then transfer is not compatible to smart relays with hardware version 1.0.08 or higher.
- If the memory cartridge was loaded from a smart relay using firmware version 4.05 or higher, then transfer is compatible with all smart relays.

For more information on how to check the firmware or hardware version, refer to the **VERSION** Menu (*see page 75*).

Compatibility

Index



A

Auxiliary Relays, *95*

C

Clocks, *132*

Compatibility

 Firmware, *187*

 Memory Cartridges, *187*

D

Discrete Inputs, *91*

Discrete Outputs, *98*

F

Firmware

 Compatibility, *187*

I

inputs-outputs, *38*

L

LD Analog Comparator, *127*

LD Change to Summer / Winter Time, *138*

LD Counter Comparators, *125*

LD Counters, *110*

LD Fast Counter, *116*

LD language Elements

 Analog Comparator, *127*

LD Language Elements

 Auxiliary Relays, *95*

LD language Elements

 Change to Summer / Winter Time, *138*

LD Language Elements

 Clocks, *132*

 Counter Comparators, *125*

 Counters, *110*

 Discrete Inputs, *91*

 Discrete Outputs, *98*

 Fast Counter, *116*

 LCD Screen Backlighting, *137*

 Message, *141*

 Modbus I/Os, *140*

 TEXT, *135*

 Timers, *101*

 Zx Keys, *93*

LD LCD Screen Backlighting, *137*

LD TEXT, *135*

LD Timers, *101*

M

Menu

 CHANGE DATE/TIME, *83*

 CHANGE SUMMER/WINTER, *85*

 CLEAR PROG., *69*

 CONFIGURATION, *61*

 DEFAULT, *79*

 LANGUAGE, *77*

 MONITORING, *57*

 PARAMETERS, *55*

 PASSWORD, *62*

 PROGRAMMING, *43*

 RUN / STOP, *59*

 TRANSFER, *71*

 VERSION, *75*

 WATCHDOG CYCLE, *67*

 Zx KEYS, *66*

Modbus LD I/Os, *140*

Z

Zx Keys, *93*

